

habitat win[®]

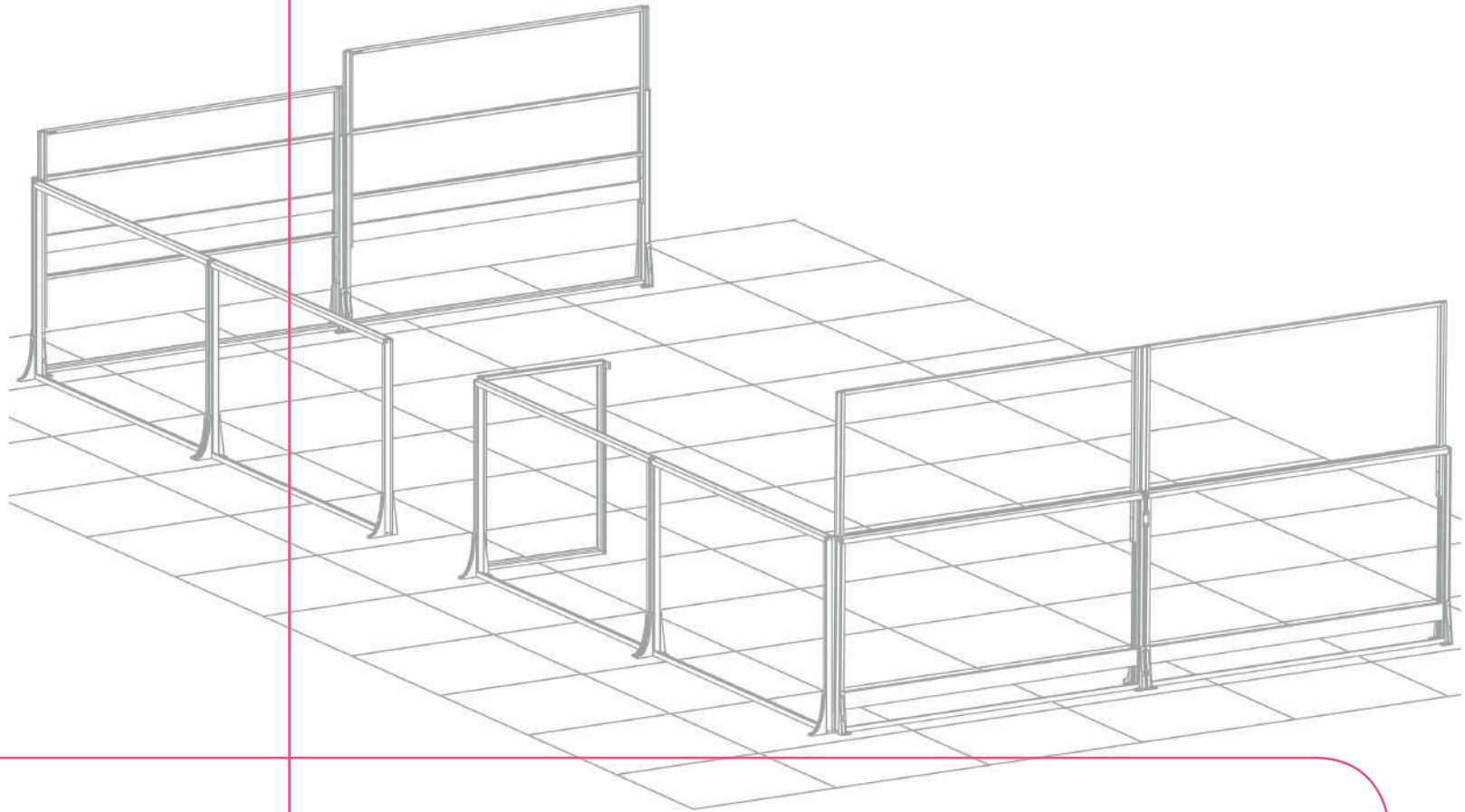

*Glass windscreens
for bespoke outdoor
solutions*





C3 Systems is highly committed to its team, its customers, its surroundings and the environment. We work every year with the aim of identifying and proposing measures that contribute to achieving sustainable, efficient and balanced economic growth. For this reason, we carry out adequate raw materials management, we preserve natural resources by promoting their responsible use, guaranteeing their supply and carrying out studies to improve and identify new opportunities for economic growth. In addition, we develop innovative products in the environmental field and we guarantee the protection of people's health and quality of life.

Look closely at the present you are building, because it must resemble the future you dream of.

~Alice Walker~

GLASS WINDBREAKER



HABITAT WIN mobile is the perfect solution to protect you from the wind and enjoy outdoor spaces to the fullest. Its innovative and versatile design allows it to be adapted to your needs at all times. With its height-adjustable mobile model, you can control the height of the windbreak according to the intensity of the wind or the desired level of privacy.

- Technical specifications..... 5
- Supports..... 6
- Complements..... 6
- Testing..... 7

New option HABITAT WIN fix adds extra protection and comfort and you can continue enjoying the outdoor space either at home or on the terrace of a HORECA channel business **creating your personalized environment**. Additionally, this option gives the possibility of installing a door.

New









- Technical specifications..... 8
- Supports and fittings..... 9
- Complements..... 10

Both systems are compatible with each other





ADVANTAGES OF MOBILE SYSTEM

-  Customize wind protection with mobile panel regulation
-  Perfect combination with our pergolas and roofs [Seesky](#)
-  Combine with the fix sections
-  Lock available for security and protection
-  All fittings and hardware with stainless steel
-  Total customization of your outdoor space
-  Perfect solution for HORECA: Hotels, restaurants, and business
-  Possibility of bespoke height dimensions

NEW SPECIAL ADJUSTABLE HEIGHT FOR GLASS WINDSCREEN SYSTEM

New measure for height adjustable glass windscreen 1550 / 2400 mm, perfect for covering open spaces such as pergolas, restaurants and similar open spaces.

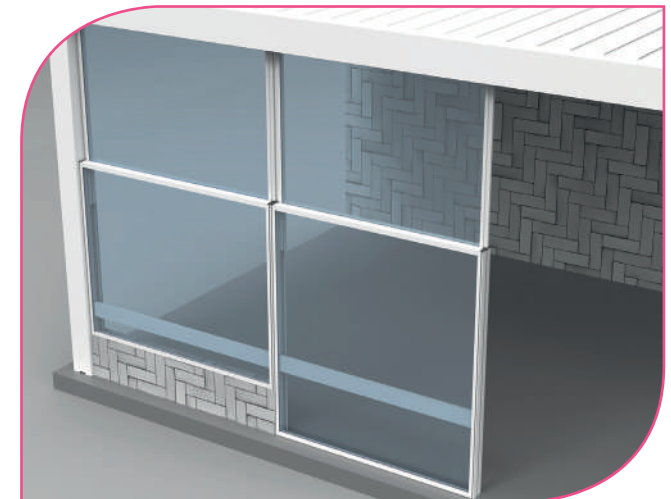
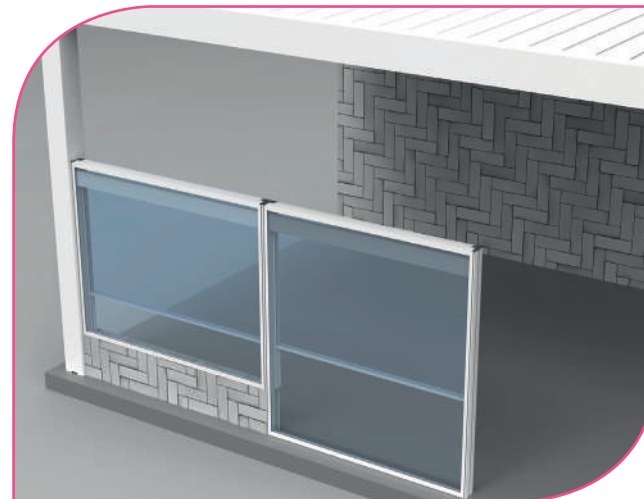

PRODUCT DETAILS



Adjustable windbreak option + planter with standard floor support.

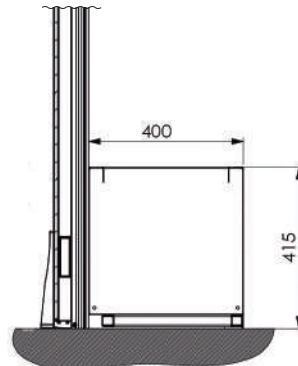

Also available as a fixed module option



Adjustable windbreak option + planter with wheel support.

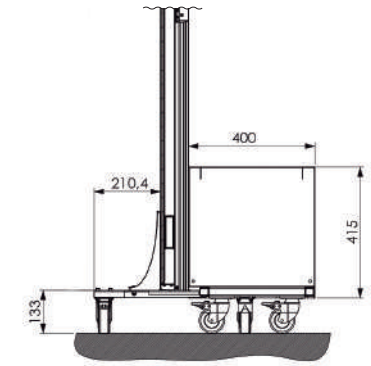

TECHNICAL SPECIFICATIONS HABITAT WIN MOBILE	
Width	Maximum 2000mm per module
Height	4 Standard measures: A (closed position) B (opened position) 1) A: 950 mm B: 1600 mm (42 Kg/ml) 2) A: 1150 mm B: 2000 mm (52 Kg/ml) 3) A: 1350 mm B: 2200 mm (56 Kg/ml) 4) A: 1550 mm B: 2400 mm (60 Kg/ml)
Glass	Laminated glass 3+3 mm or tempered glass 6 mm. Available Matt glass option.
Finishes	Stock colours: WHITE, RAL 9006 Nature, 9011 M, 7016 TX, 7016 M. Available in all RAL colors and anodized.
Installation	Various types of floors support, wall connectors, linear connections and 90° angles between modules are available. All accessories are made of stainless steel.
Options	Stop available in any point of the deployed height Lock available for blocking.

SUPPORTS AND COMPLEMENTS FOR MOBILE SYSTEM



SIMPLE/DOUBLE REINFORCED SUPPORT:
Height adjustable floor fastening support.



SHORT BASE SUPPORT:
Short height adjustable floor fastening support.



LINEAR CONNECTION:
External connection plate for straight line module connection.

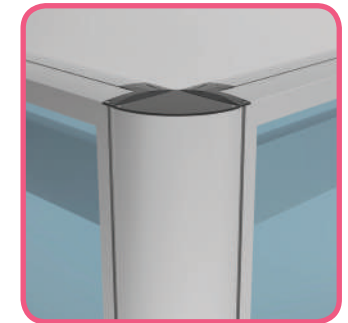

CORNER UNION PROFILE:
Decorative profile for 90° angle.



SIMPLE/DOUBLE FOREHEAD SUPPORT:
Support for front wall mounting. The double support allows the installation of modules that are joined together.

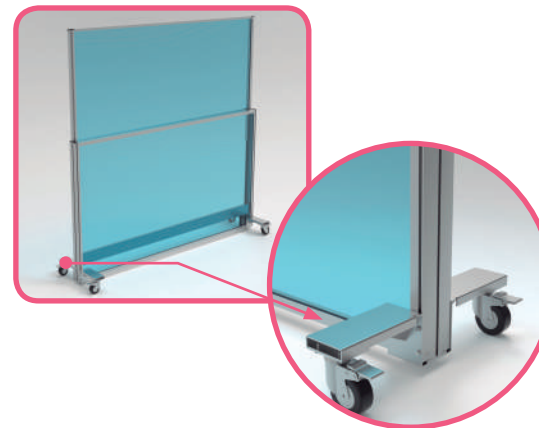

WHEELS SUPPORT:
Height adjustable bearing support with brakes on each wheel for places where fastening is not possible.



WALL SUPPORT:
Screen to wall connection plate.



LOCK:
Locking system that allow you to block the adjustable panel at the desired height.

APPROVALS AND TESTS



CE marking

All our systems are approved by an official laboratory and comply with the requirements of the European Commission to carry the CE Marking seal. We have all the tests and certificates that comply with these regulations, and we have a computer tool that makes it easier for the workshop to obtain this label.



3 years warranty in all components*

Habitat WIN has a 3 year warranty on all components.

*(To check the guarantee in detail, download the general conditions of sale in the customer area of the website)

Habitat WIN mobile it has test certificates in an approved laboratory, established by national and international legal regulations, issued by the corresponding certification bodies.

This certification assures you that choosing C3 Systems, S.L. products you are purchasing a quality product with all the necessary guarantees.

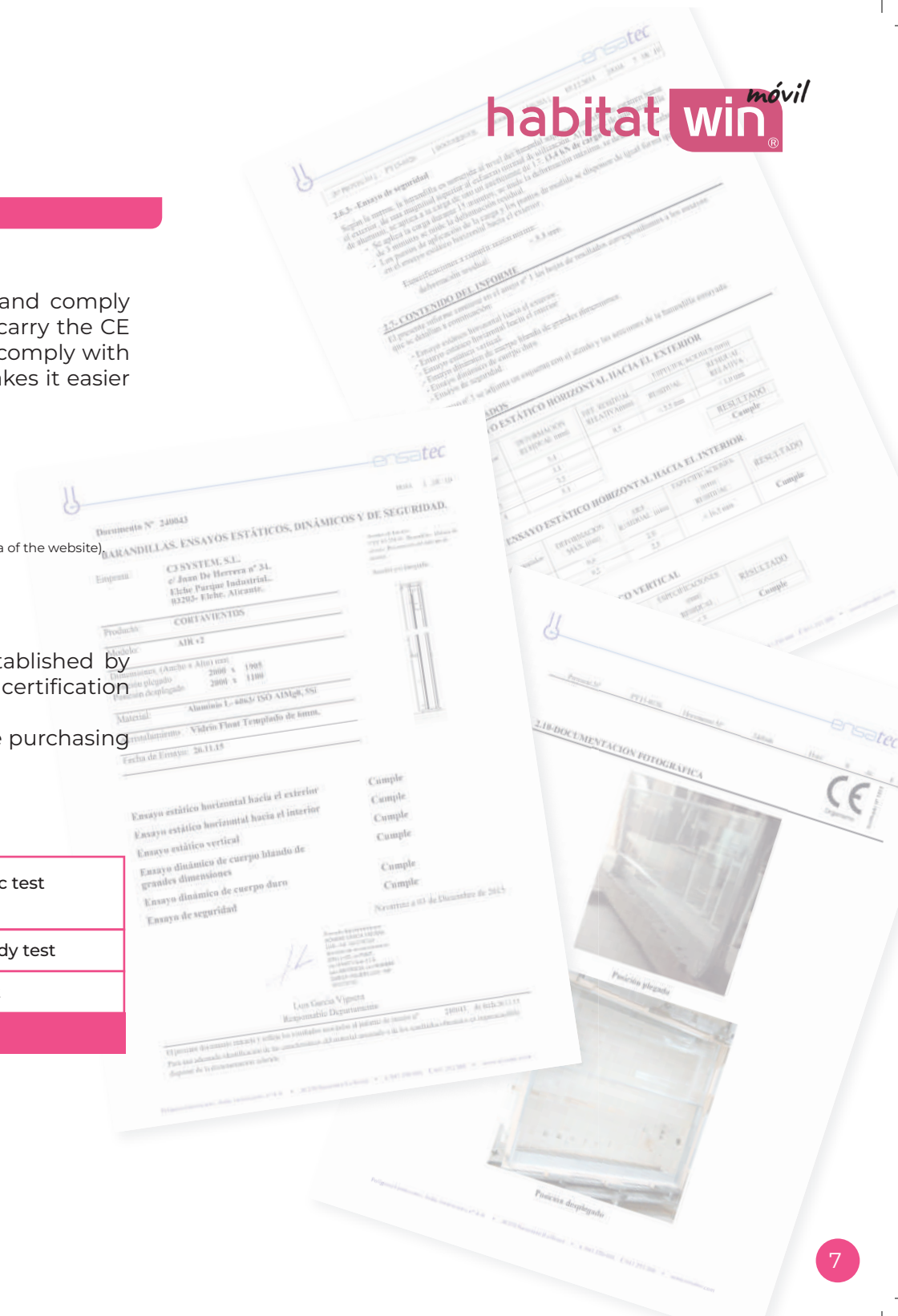

Wind resistance





UNE EN 1932:2014
CLASS 6 - 110 km/h

Horizontal static test outward	Horizontal static test inland
Dynamic hard body test	Dynamic soft body test
Vertical static test	Safety test

COMPLETED

New

ADVANTAGES OF HABITAT WIN FIX

-  Compatible with mobile version and our pergolas and roofs [Seesky](#)
-  Free and unobstructed passage thanks to the door opening at 90° and 180°
-  Fixed glass option lock for greater security
-  Perfect solution for HORECA: Hotels, restaurants, and business
-  Custom made dimensions in width and height



MODEL FIX SIMPLE
A single piece of glass custom made



MODEL FIX DOUBLE GLAZING.
With customizable horizontal profile in height for total symmetry.



MODEL FIX DOUBLE GLAZING WITHOUT TOP PROFILE
It offers an unobstructed view.

PRODUCT DETAILS

TECHNICAL SPECIFICATIONS HABITAT WIN FIX	
Width	Custom made: from 250mm to 2000mm per module
Height	Custom made: 250 mm to 2000 mm
Glass	Laminated glass 3+3 mm or tempered glass 6 mm. Available Matt glass option.
Finishes	Stock colours: WHITE, RAL 9006 Nature, 9011 M, 7016 TX, 7016 M. Available in all RAL colors and anodized
Installation	Various types of floors support, wall connectors, linear connections and 90° angles between modules are available.
Options	Opening door until 180° Customisable horizontal profiles Lock option



90° CONNECTION:
Simple union or decorative profile for 90° angle.

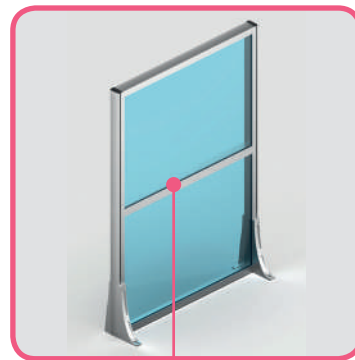

CUSTOMIZABLE PROFILE:
Height of horizontal profile fully customisable.

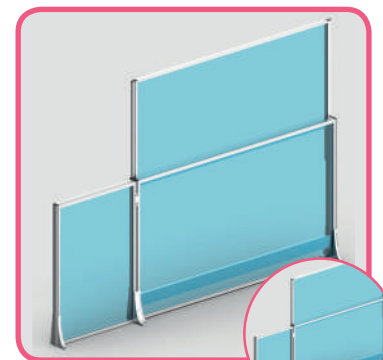

COMBINATION BETWEEN FIXED/MOBILE MODULES:
It combines the options of fixed or mobile modules, flush on the outside or inside.

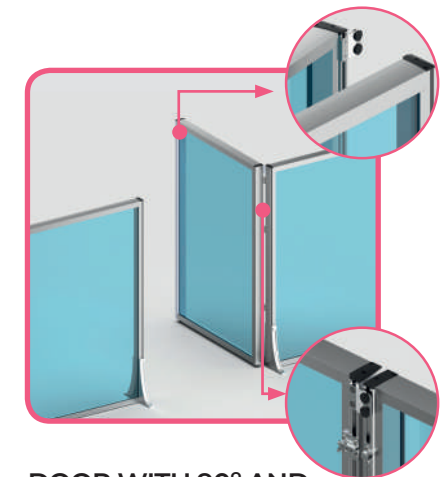

DOOR WITH 90° AND 180° OPENING:
Hinged door for opening* up to 180° with protective stops and grip lock.

*Door with 90° opening: installed with a 20 mm gap from the floor. Door with 180° opening: installed with a 270 mm gap from the floor.

FLOORING SUPPORTS



Reinforced supports simple/double



Short support simple/double



Forehead support simple/double

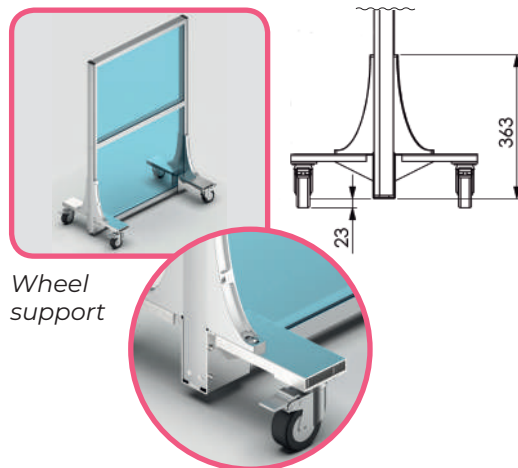

Wheel support

OPTIONS AND CONNECTIONS



WALL CONNECTION:
Module-wall connection angle at the end.



LINEAR CONNECTION:
External connection plate for straight line modules.



DOOR LATCH:
Safety accessory to close and adjust the door.

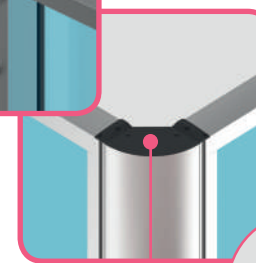

ANGLE COVER:
Cover profile for 90° angle.

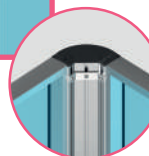

Habitat-win is available in all finishes in the RAL range, textured and matt. Visit our website to see our wide range of finishes.



The aluminum profiles used to manufacture these items comply with:

ALLOYS

Extruded in compliance with the UNE EN 12020-1 Standard
They correspond to extruded aluminum alloy 6063 and T5 heat treatment.
They comply with the composition characteristics, according to the requirements established in the UNE-EN 573-3 Standard.
They comply with the dimensional tolerances, as specified in the UNE-EN 755-2 Standard.

LACQUERED SURFACE TREATMENT

The lacquered profiles are treated in facilities authorized for the use of the QUALICOAT Quality Mark for PAINTING, LACQUERING and POWDER COATING OF ALUMINUM FOR ARCHITECTURE, in compliance with the specifications of the QUALICOAT Quality Mark Guidelines.

Why should we use aluminum for the windows of the future?

FOR ITS ENVIRONMENTAL ADVANTAGE

It is the only window material that is 100% recyclable and reusable infinite times.

It is the only one that is 100% sustainable and is effectively recycled.

This is demonstrated by the high price of its scrap metal.

The mineral with which it is produced is practically inexhaustible.

It is the only one that promotes the circular economy 100%.

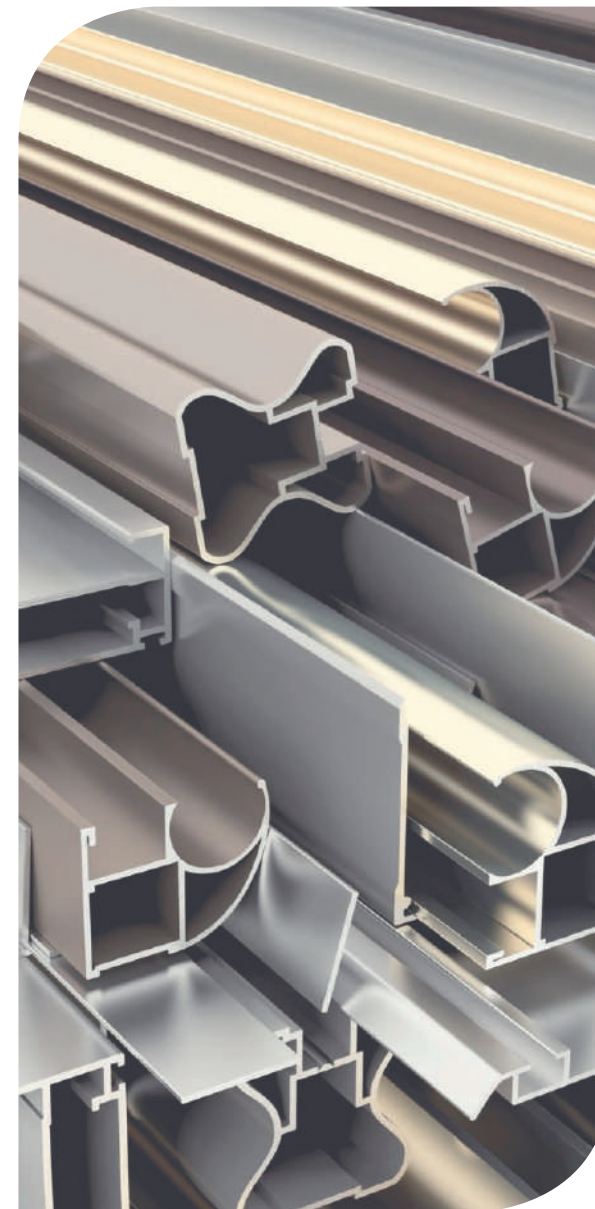



MADE IN SPAIN



C3 Systems, S.L. · C/ Ibi, 13 · Polígono Industrial Cachapets
03330 Crevillente (Alicante) España
Telf. +34 966 286 186
c3systems@c3systems.es · www.c3systems.es



ED. 9 - 2025

The purpose of this document is for commercial purpose. It does not constitute an authentic advertising offer in "strict sense". For the official offer, please contact C3 Systems S.L. in order to receive specific and personalized information that contains objective information regarding relevant characteristics which means that it will constitute an offer in a "strict sense".

C3 Systems S.L. commits not to make misleading advertising by this means. To these effects, therefore, formal or numerical errors that could be found in the content of this document are not considered as misleading advertising, in particular regarding to the image accompanying in an illustrative way, and not contractual. In any case C3 Systems S.L. commits to correct it as soon as it becomes aware of such errors.