

Looking towards the future



ANNIVERSARY

opening the world

For 15 years, we have been innovating with efficient and sustainable products, offering a personalized service that has allowed us to stay at the forefront and make a difference. Now, we have created aluminium structure systems that allow the clamping of photovoltaic glasses to create spaces that facilitate self-consumption with renewable energy.

The e-Orbita range revolutionizes solar energy with versatile photovoltaic solutions that maximize self-consumption without compromising design or functionality. Its modular and high-efficiency systems enable intelligent and sustainable space integration.

Thank you for your trust, and here's to many more years together!

ADVANTAGES OF THE RANGE



Greater energy efficiency



More self-sufficient spaces



Save energy



30-year warranty



Ideal for HORECA, homes, and businesses



Use energy according to your needs





INDEX

Product 	pag. 4-11
Product 	pag. 12-15
Product 	pag. 16-19
Product 	pag. 20
Product 	pag. 21
Finishes	pag. 22
Certifications	pag. 23



SOLAR ROOF



e-Orbita LUZ is the new generation of solar ceiling with a technology that harnesses solar energy through the installation of a structure with solar glass, whether on the roofs of residential or commercial buildings, in homes, or in the HORECA sector.

Solar glass on the roof not only provides secure savings but also increases the property's value. Join the solar revolution and unlock the full potential of your roof. Illuminate your life, care for the planet, and build a greener future.

The sun is waiting for you, what are you waiting for?

e-Orbita LUZ solar roof on an aluminum structure in an outdoor residential property

It seamlessly integrates with the **Seeglass** and **Habitat** product range to create unique environments and become the best energy-efficient, intelligent, and sustainable solution.

The advanced technology with PERC cells captures and transforms energy into electricity, ensuring optimal performance and exceptional durability with a 30-year warranty.

With a maximum energy-capturing capacity of 450Wp per solar glass, **e-Orbita LUZ** becomes one of the top solutions in energy efficiency and sustainability in the sector, created by C3 Systems.



ADVANTAGES OF THE SYSTEM

- ✓ It integrates seamlessly with **Seeglass** and **Habitat**
- 🏠 Innovative architecture thanks to its straight-line design
- 📱 Lighting with integrated home automation
- ⊗ No need for sealing in the structure

TECHNICAL SPECIFICATIONS OF THE STRUCTURE

	FIXED ROOF	
Standard lane width	1169 mm	
Standard projection	1 panel	2198 mm
	2 panels	4106 mm
	3 panels	6014 mm
Panel size	1904x1129 mm	
Slope	6° (10% ± 1%)	

DISTANCE BETWEEN PILLARS STANDARD BEAM
Without Seeglass enclosure
5000 mm.**
With Seeglass enclosure
3500 mm.**

DISTANCE BETWEEN PILLARS REINFORCED BEAM
Without Seeglass enclosure
6000 mm.**
With Seeglass enclosure
4500 mm.**

**Without snow load.

CONFIGURATIONS

e-Orbita LUZ it's a versatile system that can be installed in more example configurations. The specific configuration may vary depending on the type of location and the available attachment points in the installation.

To see examples of e-Orbita LUZ power outputs, see pages 10-11.



SECTIONS

① RIDGE PROFILE

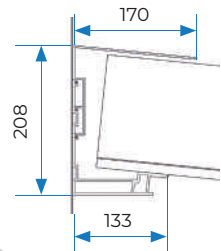

② GUTTER + STD BEAM

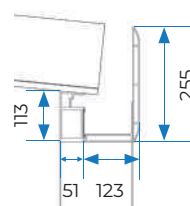

③ GUTTER + HEAVY BEAM

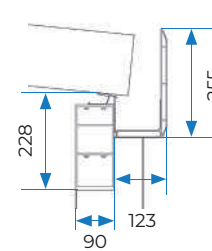

A2 BEAM PROFILE

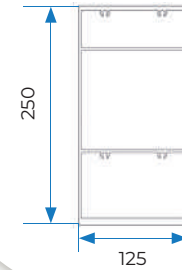

④ LATERAL GUIDE

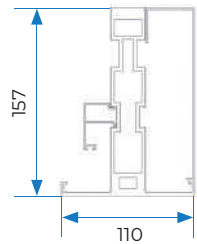

⑤ CENTRAL GUIDE

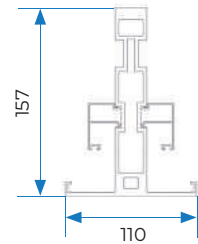

A1 RECORDABLE "U" PILLAR

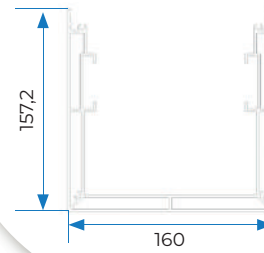

B1 CLOSED PILLAR PROFILE

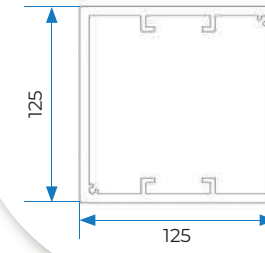

⑥ U SHAPE PROFILE

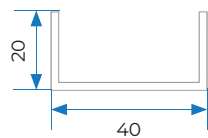

⑦ T SHAPE PROFILE

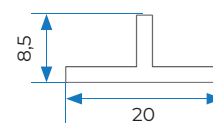

TRIMS UNDER THE PHOTOVOLTAIC GLASS

DRAINAGE AND SUPPORTS DETAILS

e-Orbita-luz features three types of supports: At the front, you can choose between the adjustable support or the reinforced adjustable support. At the rear, the canopy support is specifically designed for island configurations, without the need to anchor the system to a wall. These three supports offer flexibility in installation according to the needs of the project.

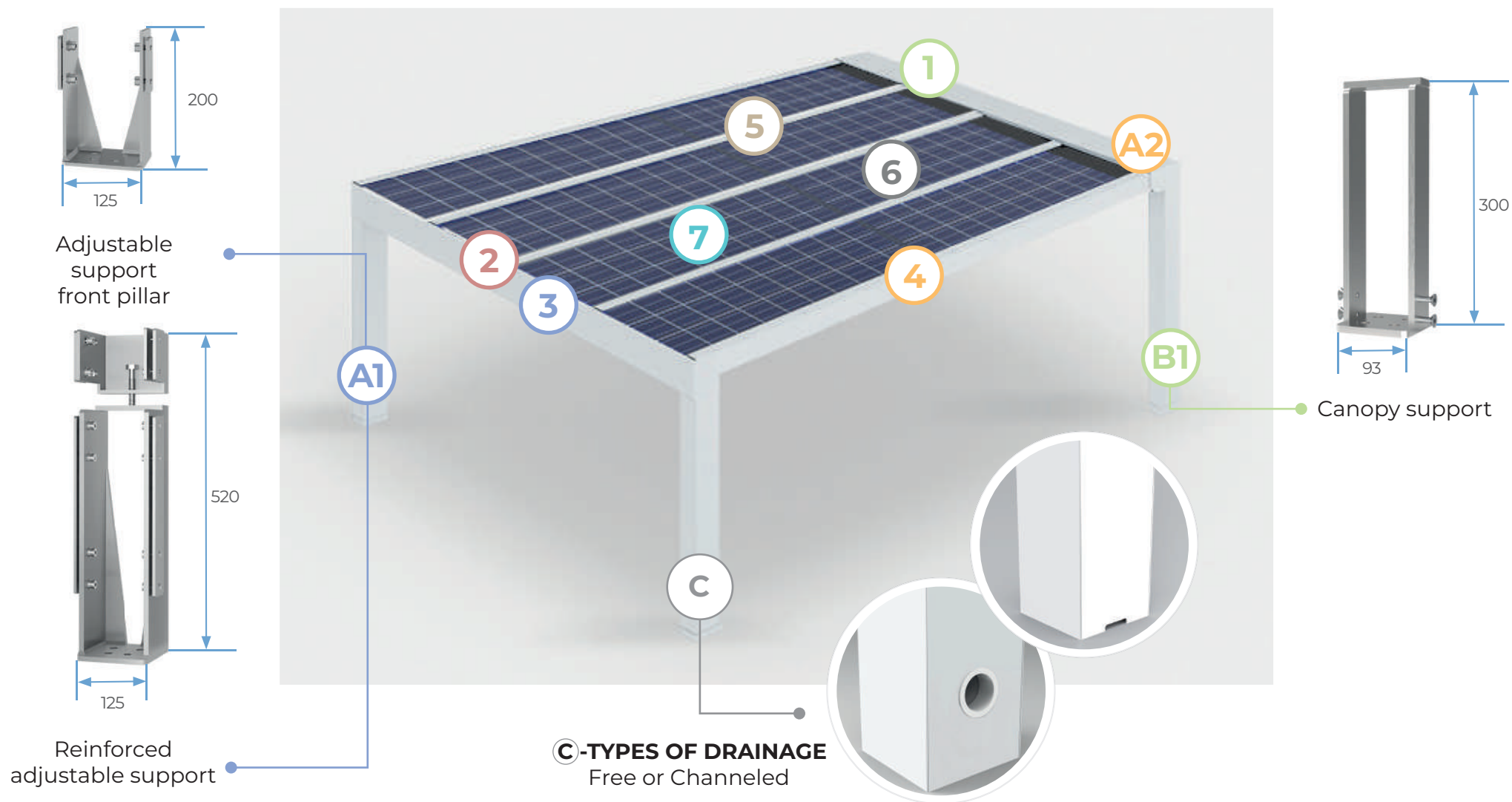

CONFIGURATIONS

e-Orbita LUZ structure in island configuration

e-Orbita-luz features the innovative island configuration. The island option is supported by an independent structure on four pillars, making it ideal for gardens, terraces, and parking areas. It provides shade, protection, and clean energy without the need for anchoring to wall.

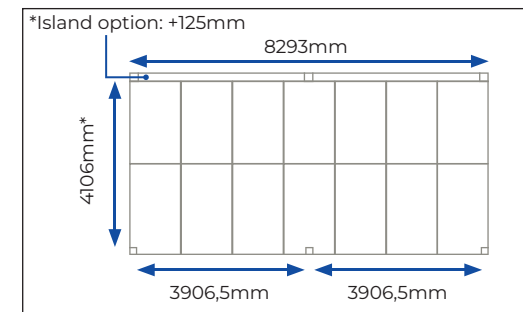

e-Orbita LUZ structure with wall configuration

e-Orbita-luz also offers the wall-mounted configuration. This is an efficient and elegant solution that attaches to a wall support, optimizing space and solar capture. Perfect for terraces, porches, and facades, it provides shade, protection, and clean energy with a harmonious architectural integration.

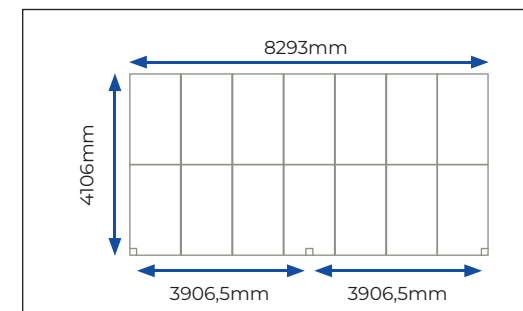
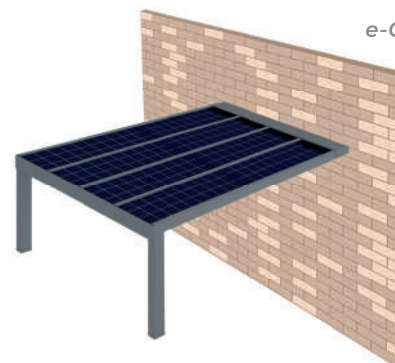

e-Orbita LUZ structure with gable roof

Lastly, the dual-pitch configuration, with a classic and efficient design that maximizes solar capture with a larger exposure surface. Perfect for homes, terraces, and commercial buildings.

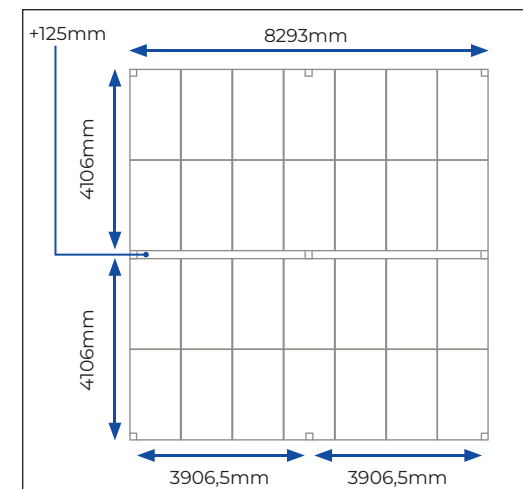

LIGHTING AND HOME AUTOMATION



e-Orbita LUZ solar roof offers the possibility, thanks to two leading home automation brands (**Teleco**, **Nice** y **Somfy**) to incorporate lighting systems and integrate them with the various installed smart sensors for intelligent space control. Create the ideal ambiance wherever you are. Experience a unique blend of comfort, cutting-edge technology, and well-being. C3 Systems' quality in a highly sustainable and efficient system.

The integration of lighting in the system includes:

- LED lights in beams and ridge profile

Furthermore, there are three color options:

- Warm white (3000K), neutral white (4000K)
- RGB

Create customizable scenarios by programming the ambient lighting.

All of this and more at the touch of a button.

Smart spaces for smart people.

An innovative system designed with you in mind.



Example measurements

e-Orbita LUZ structure configurations to wall

4KW

Max. peak power
4a 4,05 kW

4a. 3x3 panels

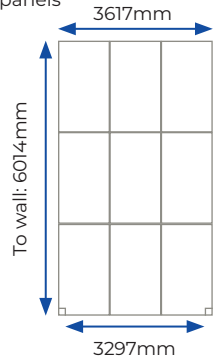

Max. peak power
4b 3,6 kW

4b. 4x2 panels

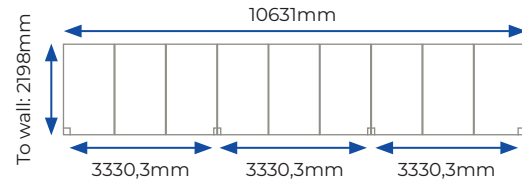
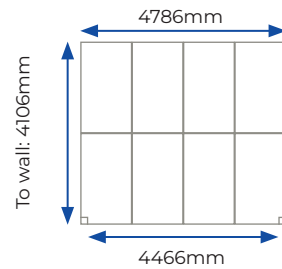

Max. peak power
4c 4,05 kW

4c. 9x1 panels

8KW

Max. peak power
8a 8,1 kW

8a. 9x2 panels

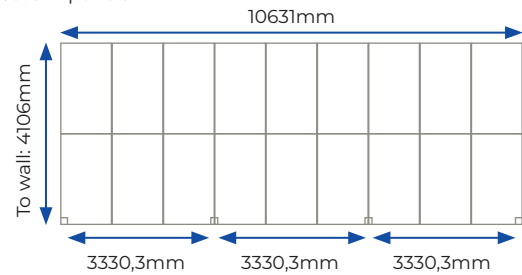

Max. peak power
8b 8,1 kW

8b. 6x3 panels

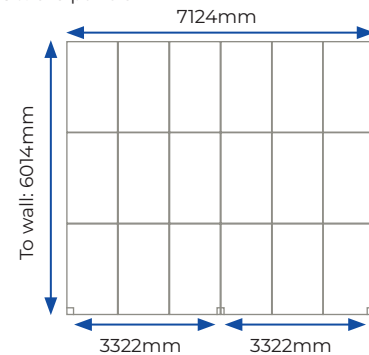

6KW

Max. peak power
6a 6,3 kW

6a. 7x2 panels

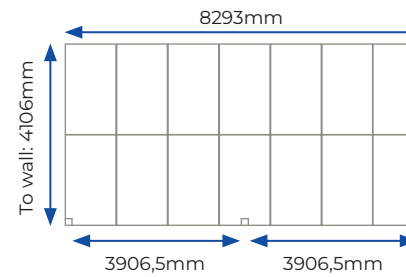

Max. peak power
6b 6,75 kW

6b. 5x3 panels

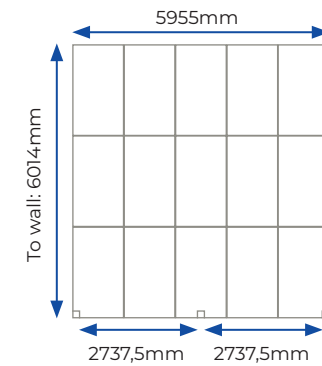

10KW

Max. peak power
10a 9,9 kW

10a. 11x2 panels

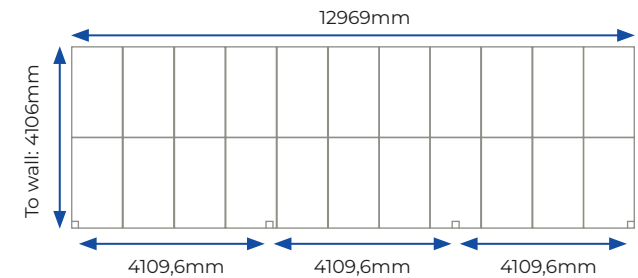

Max. peak power
10b 9,45 kW

10b. 7x3 panels

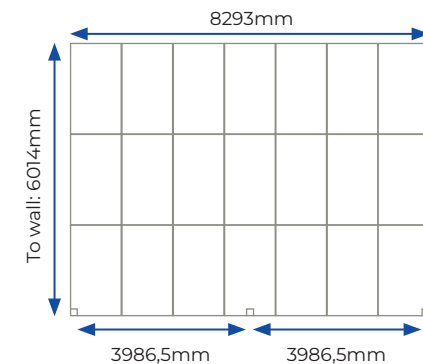

Example measurements

e-Orbita LUZ structure configurations to wall

14KW

Max. peak power

14a 14,4 kW

14a. 16x2 panels

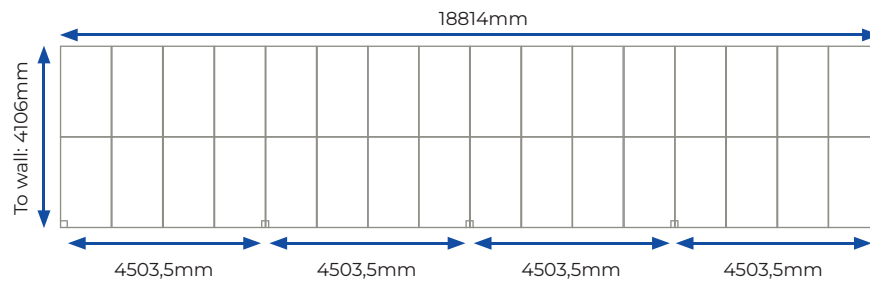

Max. peak power

14b 14,85 kW

14b. 11x3 panels

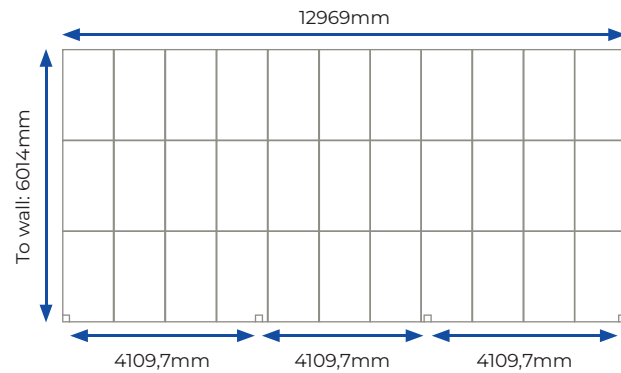

18KW

Max. peak power

18a 18,9 kW

18a. 14x3 panels

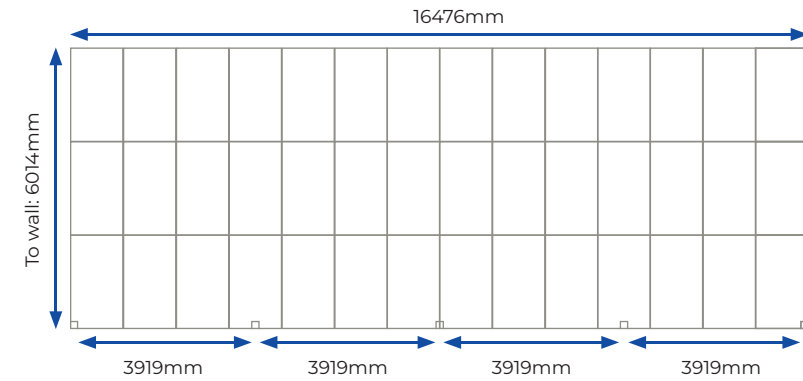

Max. peak power

18b 18 kW

18b. 20x2 panels

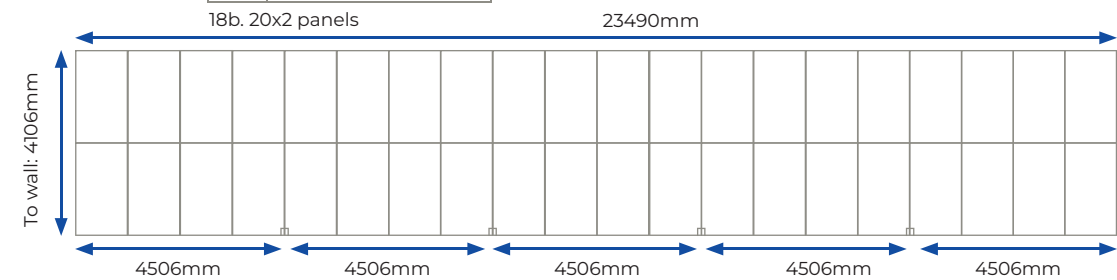

*e-Orbita LUZ can also be custom-made as per the customer's request

**The distance between pillars will depend on the configuration requested by the customer.



PHOTOVOLTAIC SOLAR CARPORT

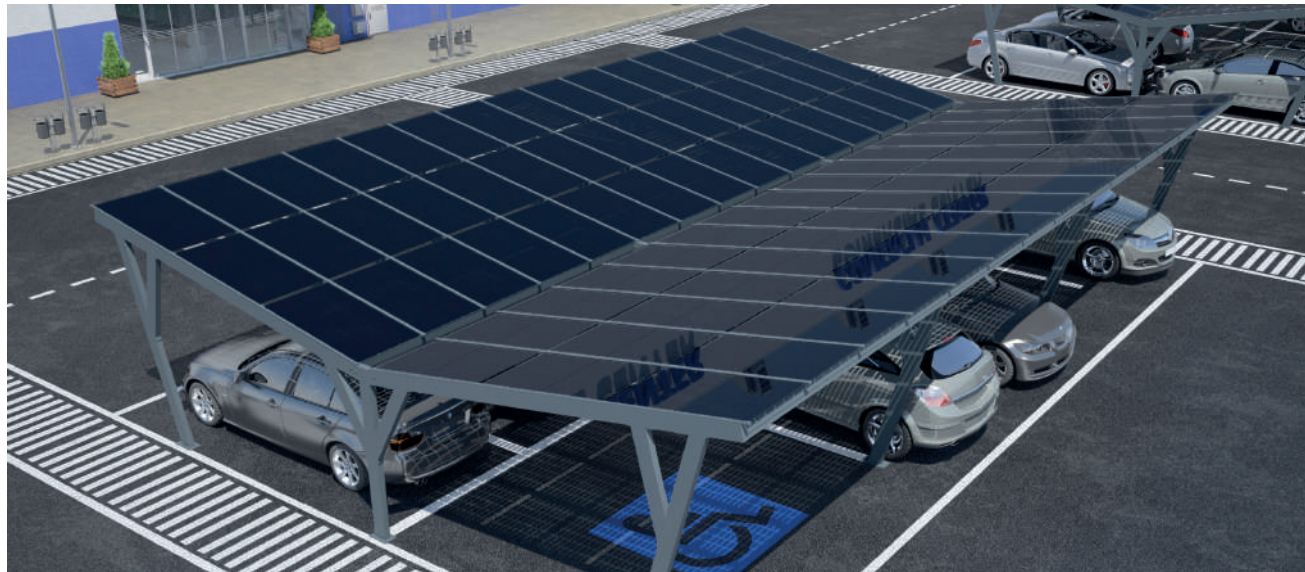

Example of an e-Orbita CAR solar carport in Y configuration (inverted gable roof)

e-Orbita CAR is the new photovoltaic solar carport, where its impressive lines make it a robust and durable system.

It incorporates photovoltaic glass for energy capture, and its design has been specifically conceived for vehicle parking.

This innovative solar parking solution not only protects your car from weather conditions but also transforms sunlight into clean and renewable energy—ideal for efficiently and sustainably charging electric vehicles.

Example of an e-Orbita CAR solar carport for two cars: 15 glass panels, 7kW/hour

The structure has been designed to optimize solar energy capture, allowing a modular installation that adapts to any space, from private residences to large corporate parking lots.

e-Orbita CAR is perfect for those seeking a sustainable solution that combines aesthetics, functionality, and a commitment to the environment.



VENTAJAS PROPIAS DEL SISTEMA



STAINLESS STEEL COMPONENTS

The entire system is made of aluminium with **stainless steel supports and joints**, offering excellent resistance to adverse weather conditions.



OUTPUT OF 3 PHOTOVOLTAIC GLASS PANELS

e-Orbita CAR allows the installation of three photovoltaic glass panels per unit, optimizing solar energy capture and maximizing system efficiency.

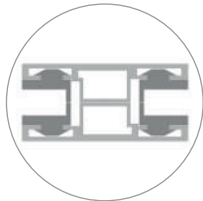

GLASS FIXATION WITH E-ORBITA CLAMP

The system incorporates e-Orbita CLAMP, an innovative fastening system designed to ensure secure, stable, and precise installation without drilling into the photovoltaic glass. It prevents water leaks throughout the structure.

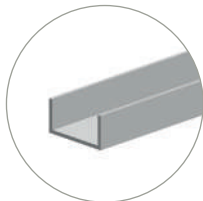

HIDDEN WIRING WITH U PROFILE

The U-profile not only enhances the overall appearance but also protects cables from external factors, offering an aesthetic and functional solution.

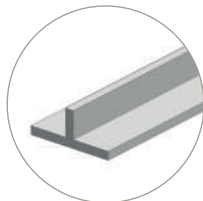

GLASS CONNECTION WITH T PROFILE

The T-profile provides a robust, aesthetic, and efficient solution for durable structures.



STANDARD VERSION

Functional and durable solar carport, ideal for generating clean energy while protecting vehicles in any outdoor environment.



REINFORCED VERSION

Offer greater structural resistance and optimal performance, allowing it to withstand higher loads. **Complies with CTE⁽¹⁾**

⁽¹⁾Consult specifications.

TECHNICAL SPECIFICATIONS OF THE STRUCTURE

	FIXED ROOF	
System maximum width	Unlimited by successions	
System maximum height	Front height	Rear height
	2500 mm	3460 mm
System fixed projection	5638 mm	
Panel size	1904x1129 mm	
Slope	10°	

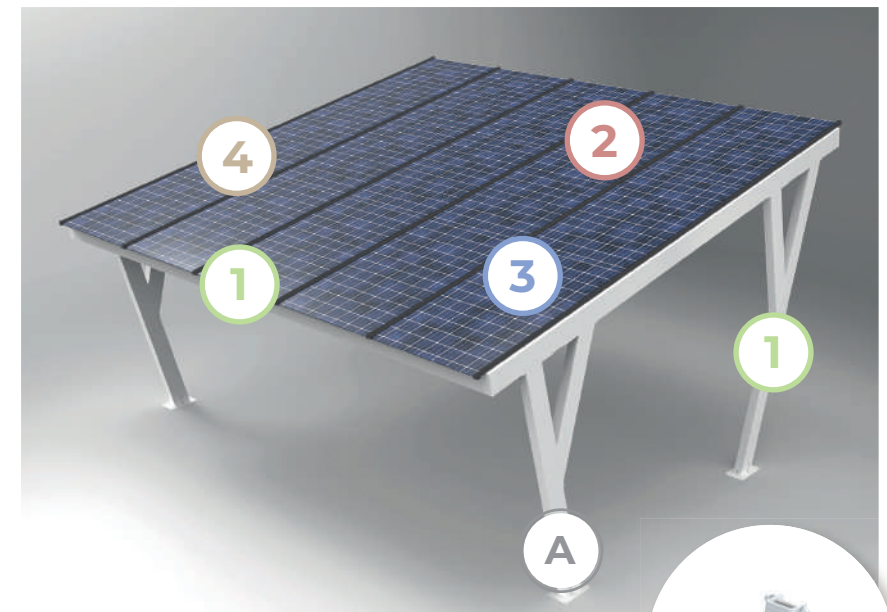

SECTIONS

1 | PILLARS & BEAMS

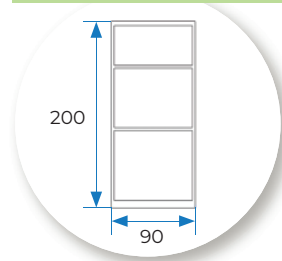

2 | INTERMEDIATE BEAM

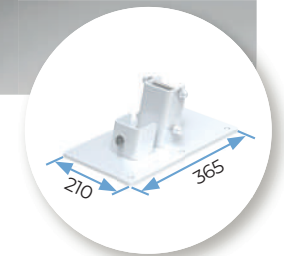
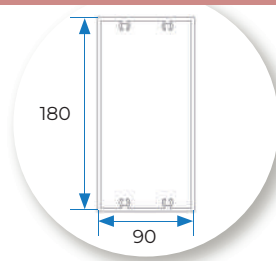

A - TYPE OF SUPPORT
- Floor support

3 | U-PROFILE

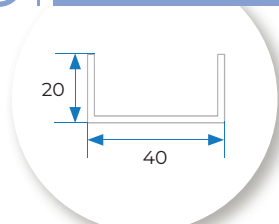

4 | T-PROFILE

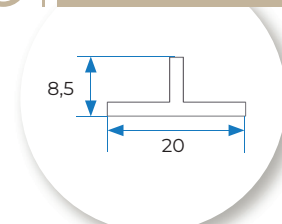

TRIMS UNDER PHOTOVOLTAIC GLASS

5 | SIMPLE CLAMP KIT

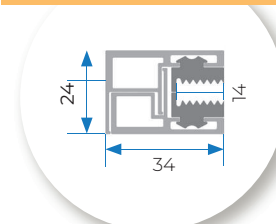

6 | DOUBLE CLAMP KIT

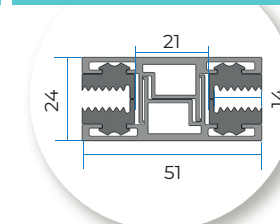

CONFIGURATIONSS EXAMPLE

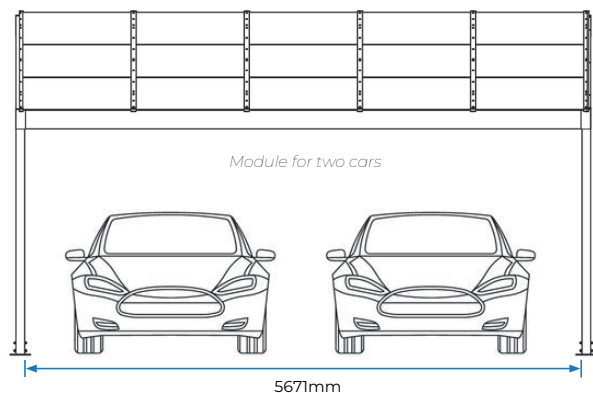

Max. peak power
6,75 kW

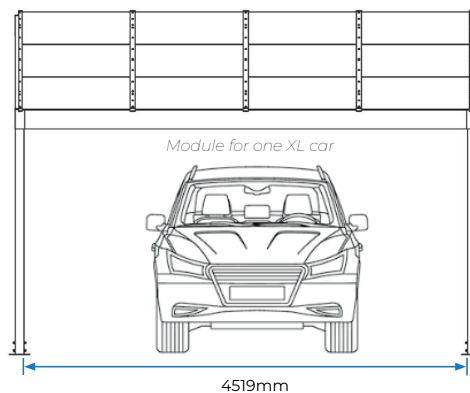

Max. peak power
5,4 kW

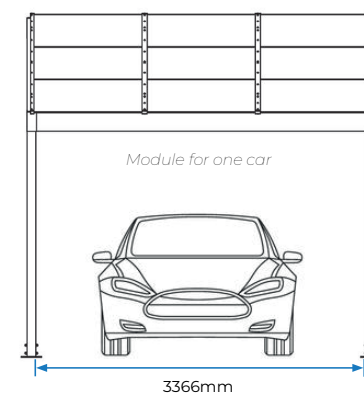

Max. peak power
4,05 kW

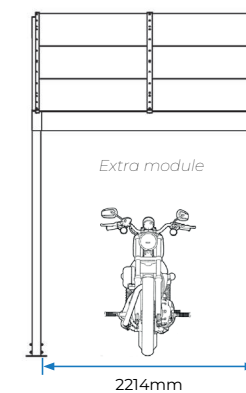

Max. peak power
2,7 kW

SPECIAL CONFIGURATIONS

e-Orbita CAR is a versatile system that adapts to different needs and environments. In addition to the 1-module configuration, it is available in 2 other configurations:

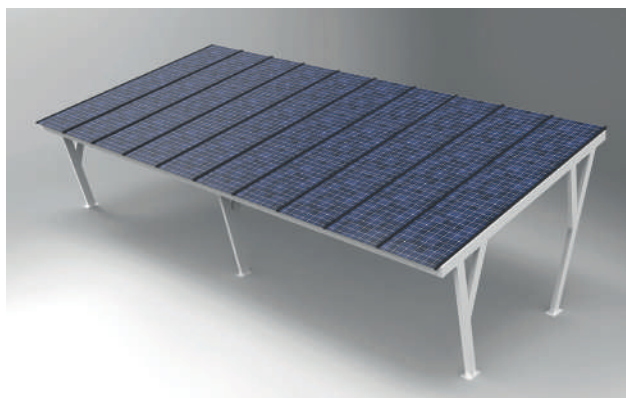

SUCCESSIVE CONFIGURATION
Several modules layout that optimizes space in large parking areas. Successions with a maximum of 5 lanes between pillars can be realised.

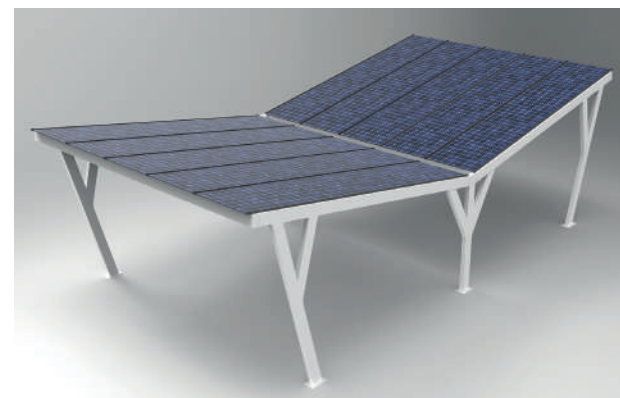

Y CONFIGURATION
Innovative design that allows for greater solar light capture thanks to its gable roof inverted disposition, ideal for large parking surfaces.



LIGHTWEIGHT PHOTOVOLTAIC STRUCTURE

e-Orbita COVER is an innovative, lightweight, and versatile photovoltaic structure designed to provide an efficient solution for self-consumption energy projects. It covers spaces to protect against weather conditions while allowing light to pass through, simultaneously capturing solar energy.

Made from high-quality materials, this structure stands out for its lightweight nature, making it the ideal choice for those seeking a modular system with an easy and quick installation while maintaining high performance.



e-Orbita COVER, is not only resistant and aesthetically appealing but also adapts to various surfaces, making it perfect for both residential and commercial projects.

Thanks to its low maintenance and long lifespan, it is the ideal solution for those looking to maximize solar energy utilization without compromising functionality or design.





STANDARD VERSION

e-Orbita COVER, in its standard version, is a lightweight photovoltaic structure, perfect for generating energy and providing shade in outdoor spaces.

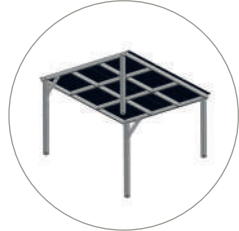

REINFORCED VERSION

Intermediate beams and reinforcement crossbars provide greater stability and resistance. Complies with CTE⁽¹⁾

⁽¹⁾Consult specifications.

SYSTEM OPTIONS



REINFORCEMENT CROSSBEAM OPTION

The reinforcement crossbeam option for e-Orbita COVER is designed to enhance the structural strength of the system, increasing its safety and extending its lifespan.



WALL-MOUNTED OPTION

The system allows for wall installation, optimizing space and ensuring secure and aesthetic structural integration without the need for anchoring to floor.



WIRE OPTION

e-Orbita COVER also has a stainless steel wire option. It is an alternative to the reinforced option, providing the structure with stability and resistance.



SYSTEM ADVANTAGES



SUCCESSIVE MODULES

Maximizes space usage with an orderly and functional design, making it ideal for large surfaces

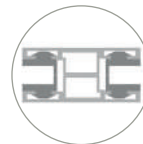

GLASS FIXATION WITH E-ORBITA CLAMP

e-Orbita CLAMP ensures secure installation and robust fixation of photovoltaic glass panels. It prevents water leaks throughout the structure.

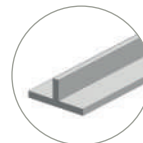

GLASS CONNECTION WITH T PROFILE

The T-profile provides a robust, aesthetic, and efficient solution for durable structures.

APPLICATIONS



PUBLIC SPACES AND PARKS

This type of system is ideal for parks and plazas, providing shade and sun protection in rest areas, benches, or green spaces.



SPORTS AND RECREATIONAL AREAS

In sports facilities, schools, or leisure spaces, this type of canopy is an excellent solution for powering the lighting of the venue.



PORCHES AND GARDENS

This system can be installed in residential porches and gardens, offering an elegant and functional aesthetic while contributing to energy efficiency.



TERRACES AND PENTHOUSES

This system also adapts to installation on terraces or penthouses of buildings, optimizing space usage for energy generation without affecting architectural aesthetics.



TECHNICAL SPECIFICATIONS OF THE STRUCTURE

	FIXED ROOF		
Maximum width	Unlimited by successions		
System fixed projection	5°	10°	20°
1 photovoltaic glass	1896 mm	1875 mm	1789 mm
2 photovoltaic glasses	3797 mm	3754 mm	3582 mm
3 photovoltaic glasses	5703 mm	5638 mm	5380 mm
Panel size	1904x1129 mm		
Slope	Adjustable (recommended from 5°-20°)		

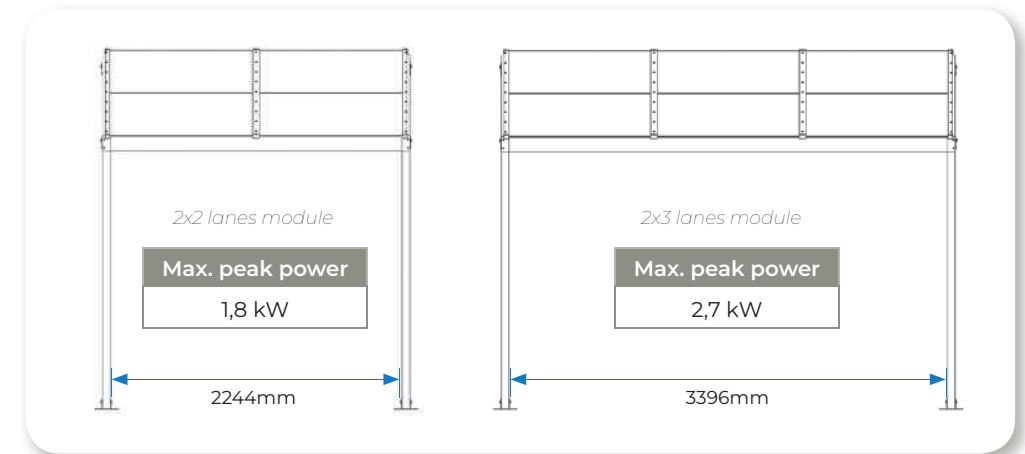

SECTIONS

1 BEAMS AND PILLARS

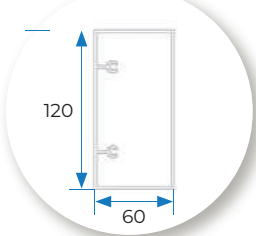

2 T-PROFILE

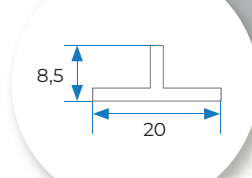

TRIMS UNDER PHOTOVOLTAIC GLASS

3 SIMPLE CLAMP KIT

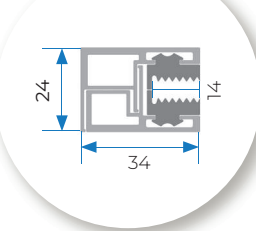

4 DOUBLE CLAMP KIT

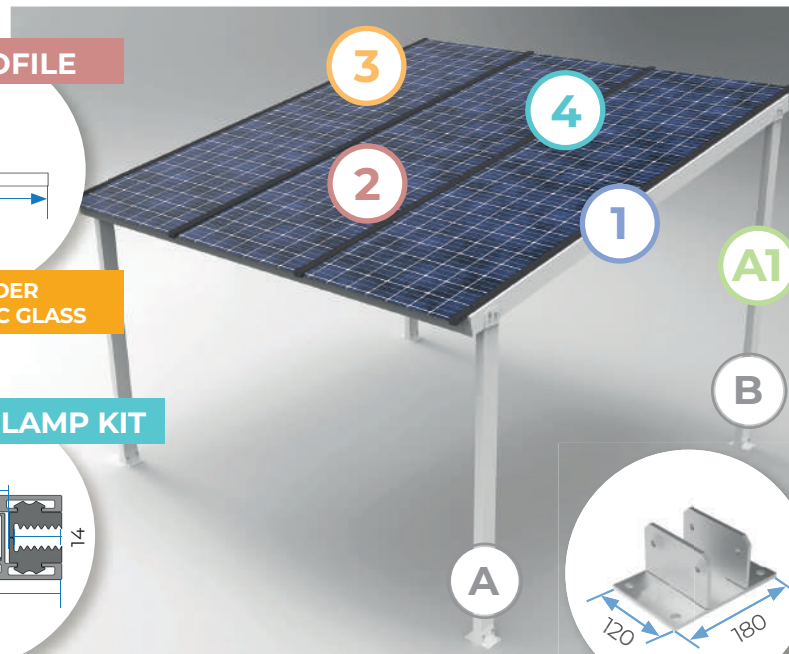
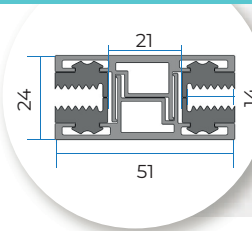

A1 CLOSED PILLAR PROFILE

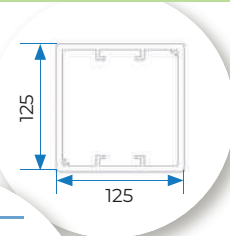

A1

B

B- REINFORCED SUPPORT

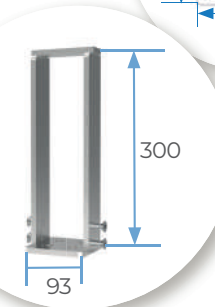

REINFORCED OPTION

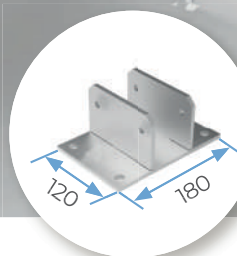

A - FLOOR SUPPORT

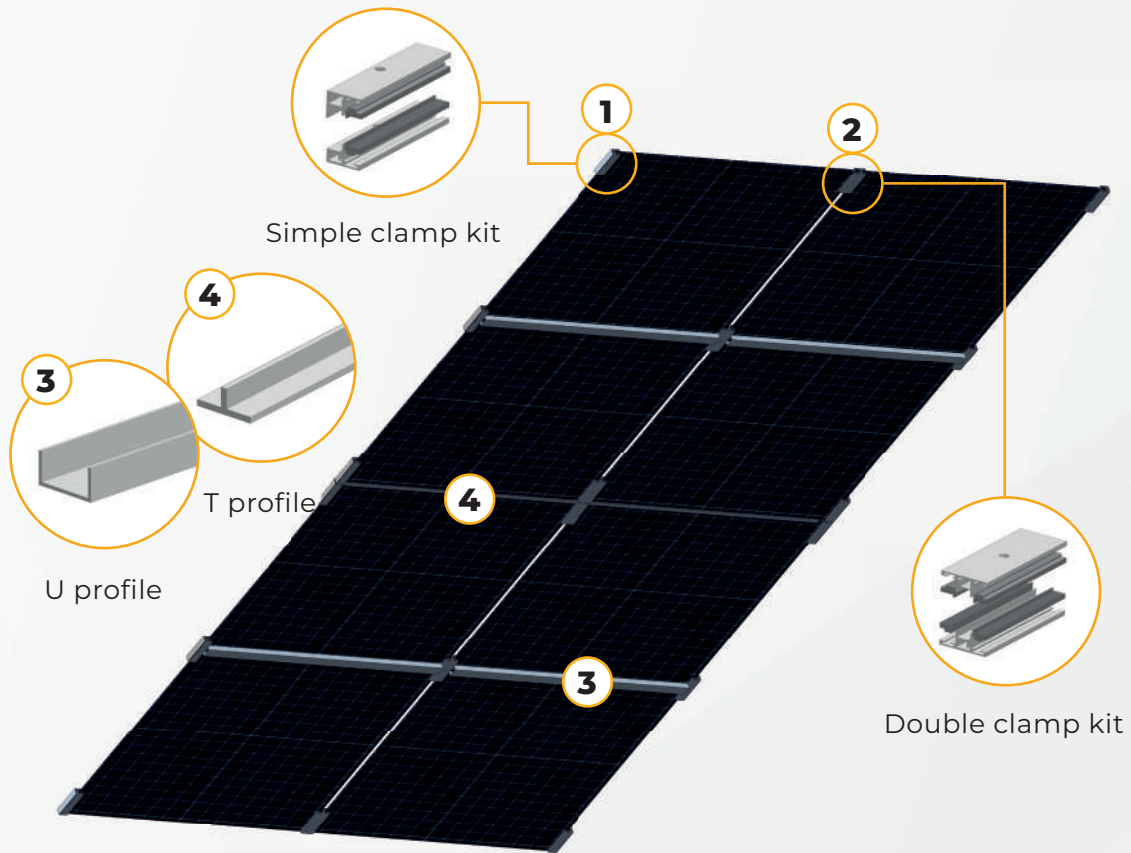

Ex. representation of the clamping of 4 glasses
Suitable for all types of structures

CLAMPING SYSTEM

e-Orbita CLAMP designed to offer a safe, efficient, and elegant solution for the integration of solar energy in homes and businesses. It is a **patented system** with an innovative design made of high quality materials. Our clamps ensure a firm and secure hold on photovoltaic glass, who prevents water infiltration throughout the structure, providing peace of mind and confidence to our customers.

Available in both single kits and 6,300mm long assemblies.

SECTIONS

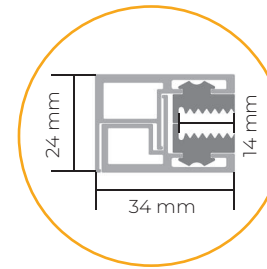

Simple clamp kit

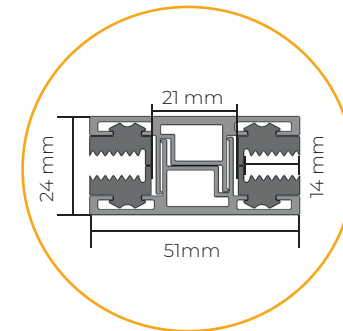

Double clamp kit



FINISHES



Raw



RAL 5004 Mat

ALUMINIUM ALLOYS

Standard UNE EN 12020-1 - Extruded aluminium alloy 6063 and heat treatment T6 - Complies with Standard UNE-EN 573-3 - Standard UNE-EN 755-2.

STRAIGHT LIP WEATHERSTRIP - EPDM

EPDM rubber is abrasion and wear resistant.

For frameless photovoltaic modules

Suitable for lateral and central assembly

PHOTOVOLTAIC GLASS

The bifacial flame retardant photovoltaic glass **e-Orbita GLASS**, is an advanced solution that combines energy efficiency and safety in a single application. This advanced glass not only captures solar energy efficiently from both sides, but also has flame-retardant properties that make it ideal for applications in demanding environments.

With C3 Systems' fire-retardant bifacial photovoltaic glass, you can enjoy maximum efficiency, safety, and elegance in every photovoltaic installation.

TECHNICAL ESPECIFICATIONS OF SOLAR GLASS



30 years warranty



Higher energy generation

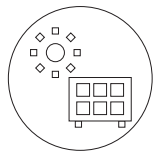

Bifacial solar panels



PERC cell technology with the highest efficiency

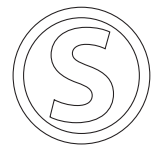

High power output (450Wp)

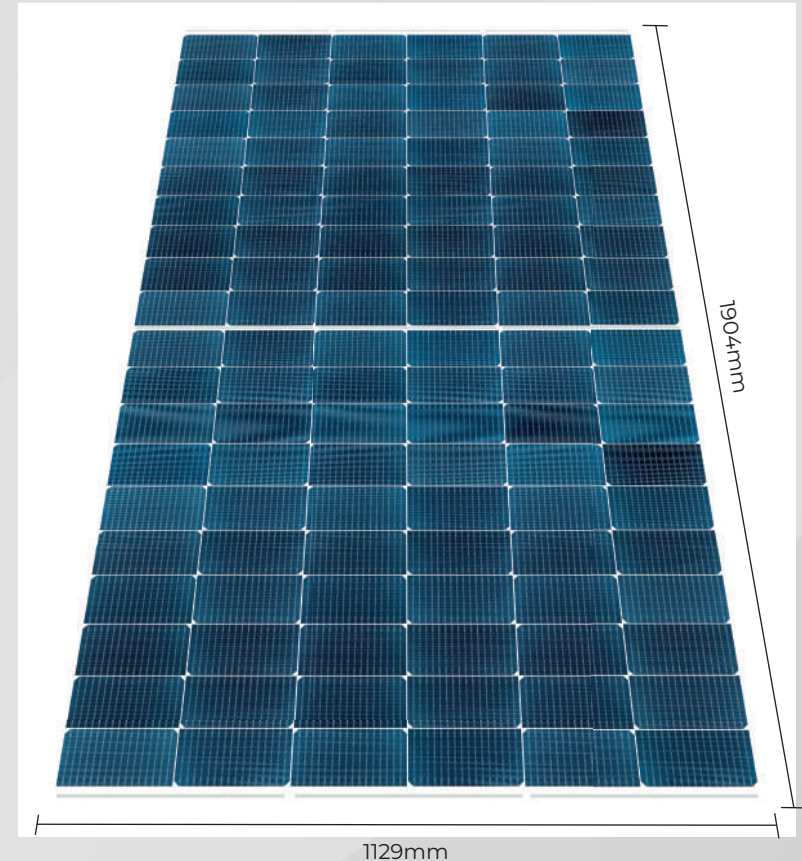

Class A - Against fire (Fireproof)



e-Orbita GLASS technical sheet

e-Orbita is available in all finishes from the RAL range, textured, and matte. Visit our website to explore our extensive range of finishes.



The aluminum profiles used in the manufacturing of these items comply with:

ALLOYS

They are extruded in compliance with Standard UNE EN 12020-1. They correspond to extruded aluminum alloy 6063 with T5 heat treatment. They meet the composition requirements as specified in Standard UNE-EN 573-3. They also meet the dimensional tolerances as specified in Standard UNE-EN 755-2.

SURFACE FINISHING – PAINTING

The painted profiles are treated in facilities authorized for the use of the QUALICOAT Quality Mark for PAINTING, COATING, and POWDER COATING OF ALUMINUM FOR ARCHITECTURE, in compliance with the specifications of the QUALICOAT Quality Mark Guidelines.



Why should we use aluminum for the windows of the future? FOR ITS ENVIRONMENTAL ADVANTAGE

It is the only material for glass systems that is 100% recyclable and can be used again and again.

It is the only material that is 100% sustainable and effectively recyclable.

The mineral from which it is made is available in virtually unlimited quantities

It is the only material that supports a 100% recycling economy.

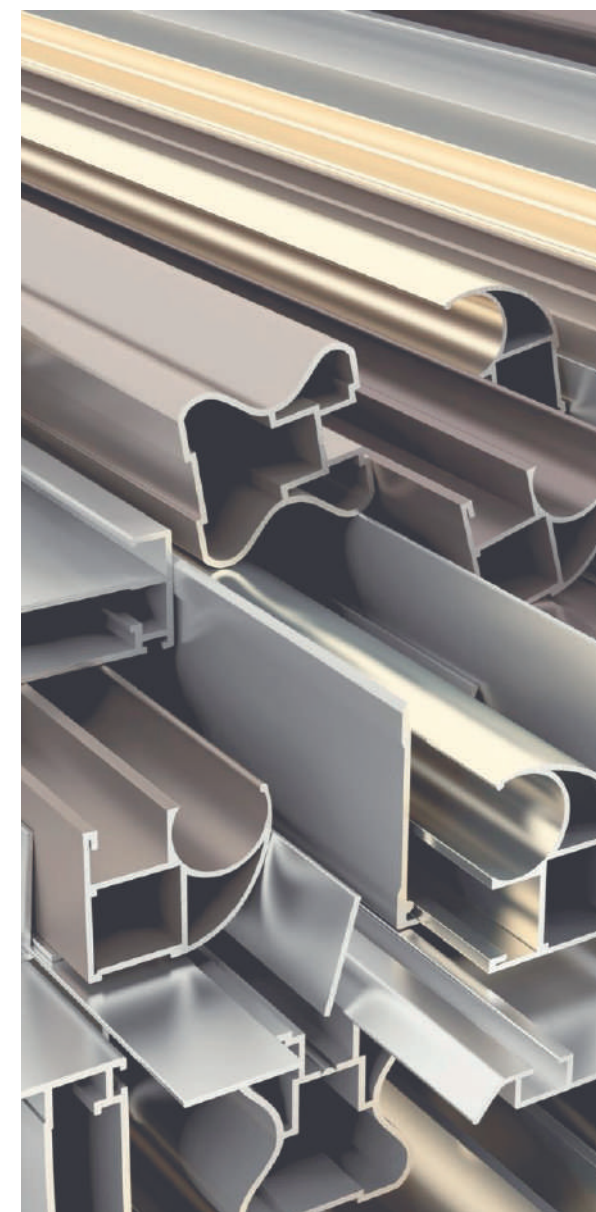

Certifications

HIGHEST RATING IN TESTS* E-ORBITA RANGE



Wind resistance
UNE EN 1932:2014

Class 6 - 101 km/h



Water tightness
UNE EN 14963:2007

Class 1A - 210 l/m²xhour



Snow resistance
UNE EN 12833

e-Orbita LUZ: 160 kg/m²
e-Orbita CAR: 180 kg/m²
e-Orbita COVER: 150 kg/m²

***Highest rating in tests with large dimensions**

APPROVALS

Maximum energy capture capacity 450 Wp per photovoltaic solar glass.



Quality assurance and safety warranty for products from manufacturers in the metal industry, including those for metal structures.



CE Rated

All our systems are certified by an official laboratory and comply with the requirements of the European Commission to bear the CE Mark. We have all the tests and certificates that meet this regulation, and we have a computer tool that makes it easier for the workshop to obtain this label.



30-year warranty*

e-Orbita GLASS has a 30-year warranty on power generation and a 15-year warranty on components.

*(Refer to the sales conditions).



Photovoltaic frameless solar glass

Compliance with new international standards 180/IEC. Excellent low-light performance, resistant to salt mist and ammonia corrosion.

Certified by the international quality and environmental management system.

Application Class: A | Electrical Safety Class: II | Fire Class: A | PERC cell technology





CATÁLOGO



CATALOGO



Videos Orbita.

MADE IN SPAIN



C3 Systems, S.L. · C/ Ibi, 13 · Polígono Industrial Cachapets
03330 Crevillente (Alicante) España
Telf. +34 966 286 186
c3systems@c3systems.es · www.c3systems.es



ED. 6 - 2025

The purpose of this document is for commercial purpose. It does not constitute an authentic advertising offer in "strict sense". For the official offer, please contact C3 Systems S.L. in order to receive specific and personalized information that contains objective information regarding relevant characteristics which means that it will constitute an offer in a "strict sense".

C3 Systems S.L. commits not to make misleading advertising by this means. To these effects, therefore, formal or numerical errors that could be found in the content of this document are not considered as misleading advertising, in particular regarding to the image accompanying in an illustrative way, and not contractual. In any case C3 Systems S.L. commits to correct it as soon as it becomes aware of such errors.