

seesky bio[®]

Bioclimatic pergola

*Cutting-edge
technology for an
efficient and
adaptable space*

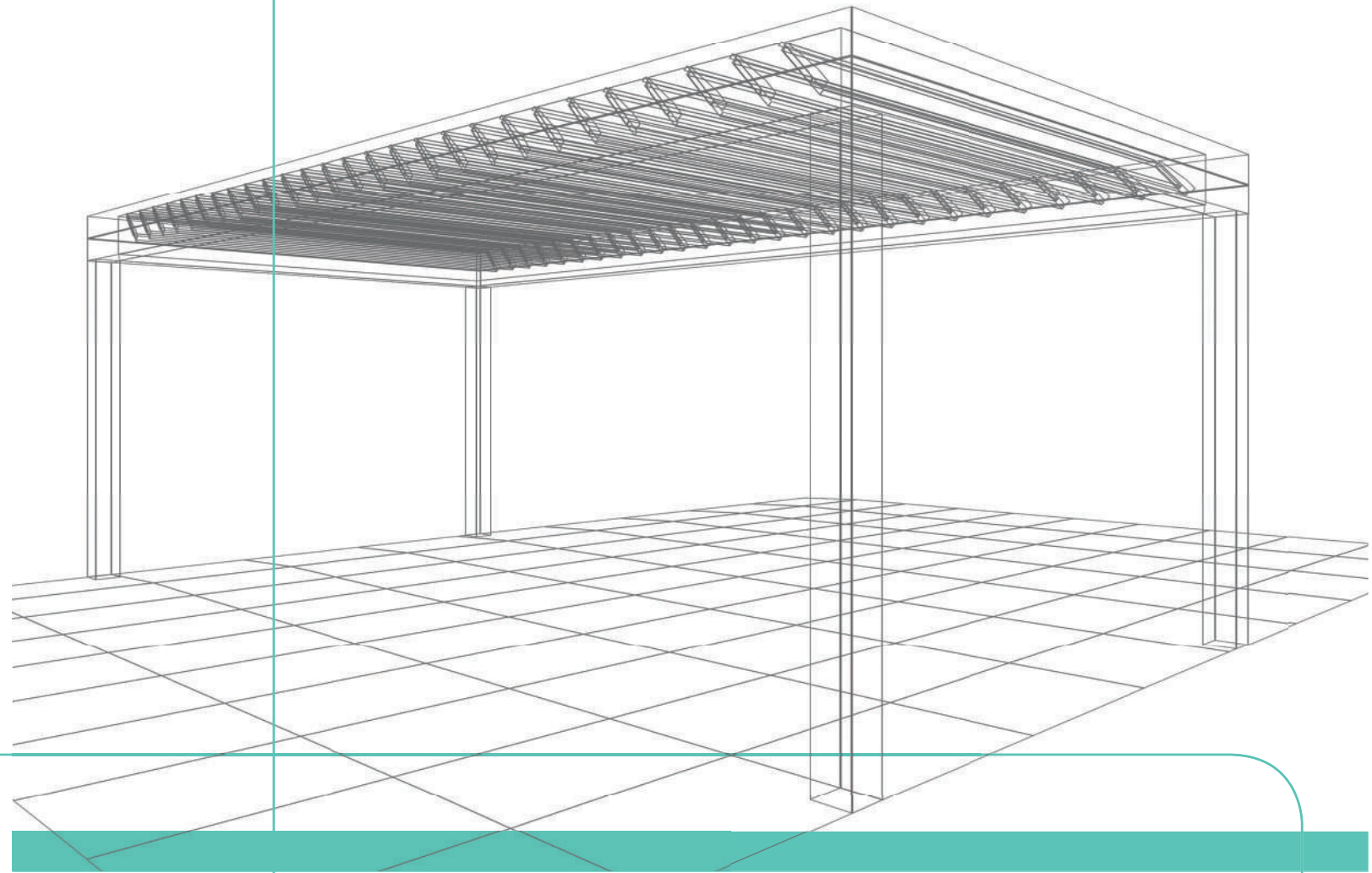



Looking to the future

For 15 years, we have innovated with efficient and sustainable products, offering a personalized service that has allowed us to stay at the forefront and make a difference.

Seesky BIO is renewed to design more comfortable and intelligent spaces. Its adjustable slat system regulates temperature and light, providing comfort all year round. Technology, design, and efficiency to improve your quality of life.

Thank you for your trust, and here's to many more years together!





INDEX

Characteristics	pag. 4
Technical details	pag. 7-8
Possible configurations	pag. 9-10
Possible options	pag. 11
Automation	pag. 12-13
Combined with glazing systems	pag. 14
Combined with complementary products	pag. 15
Finishes	pag. 16
Testing and certificates	pag. 17

SMART SOLAR PROTECTION



VENTILATION

With the different degrees of orientation of the slats, the temperature can be regulated naturally and ventilation in the room is maintained thanks to the passage of air, optimizing the energy efficiency of the space.

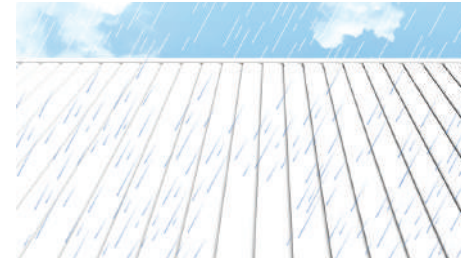

RAIN PROTECTION

Specially designed roof aluminum slats collect water and using a pipeline system take collected water through lateral columns to the outside.

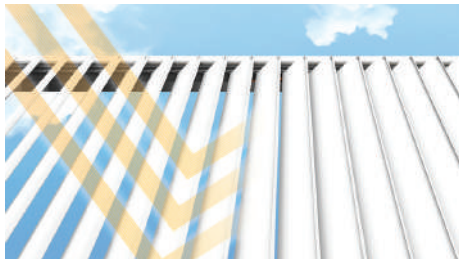

UV RAY RADIATION PROTECTION

Thanks to the motorized adjustable slats with different degrees (45°, 90° and 135°) we avoid direct exposure to ultraviolet rays and achieve the maximum possible protection.



INTEGRATED HOME AUTOMATION

360° connectivity: integration with the different protocols most used in automation and full compatibility to create environments with all the technological devices installed.

UNION BETWEEN BEAMS AND PILLARS

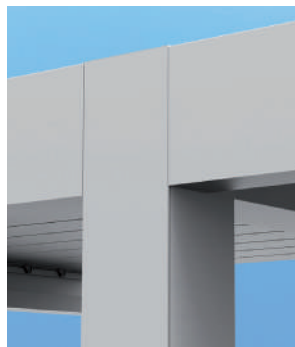

The union between the beams and the pillars is made by anchoring and internal fixing with **hidden screws**, achieving an elegant, modern and high-quality finish. In addition, you only need one pillar for the union of successive pergolas.

SEALING GASKETS



With the sealing gaskets at the junction of the machined profiles in the Beam-Pillar fastening, we significantly reduce potential water leaks in the pergola structure, achieving greater efficiency and optimizing the system's waterproofing.

TECHNICAL DETAILS



PIPELINE DRAINAGE IN PILLAR

The pillar in "U" allows drainage through any of the pillars of the pergola.

Novelty 2025



HIGH CAPACITY GUTTER

Seesky BIO features a new high-capacity gutter designed for optimal drainage. Its increased capacity ensures efficient water evacuation, enhancing performance and protecting the space.



ANTISPLASH SYSTEM (PATENTED)

Seesky-bio features a modern anti-splashing system for inside protection and dirt collection.



RECORDABLE COLUMN

The installation and maintenance of pergola is very easy and comfortable thanks to the recordable column.

This option is very useful where there is not much space to tighten screws and adjust inside cables.



SLATS WITH POLYSTYRENE *Optional*

Adding polystyrene into slats allows us to create a sound isolation when it rains.

SECTIONS

① **STD SLAT**

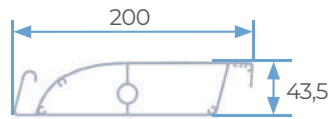

② **XL SLAT**

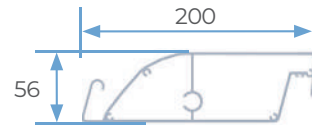

③ **FRONT SLAT COVER**

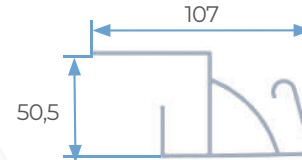

④ **BACK SLAT COVER**

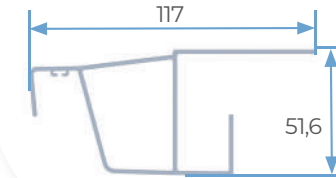

⑤ **STD BEAM**

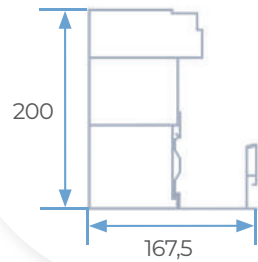

⑤A **STD BEAM + HIGH CAPACITY GUTTER**

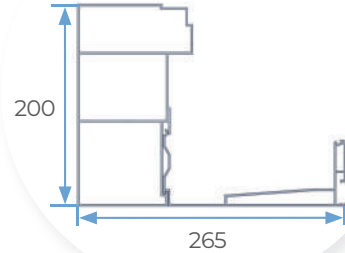

⑥ **HEAVY BEAM**

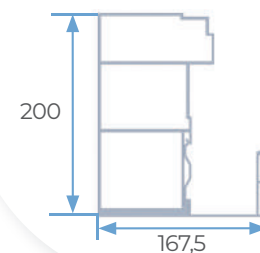

⑥A **HEAVY BEAM + HIGH CAPACITY GUTTER**

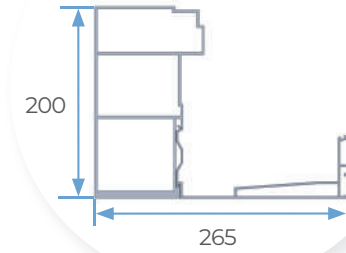

⑦ **RECORDABLE PILLAR**

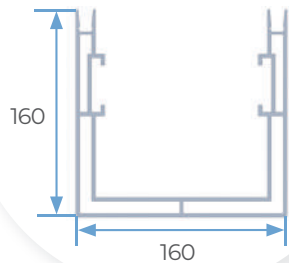

⑧ **UNION BEAM (A)**

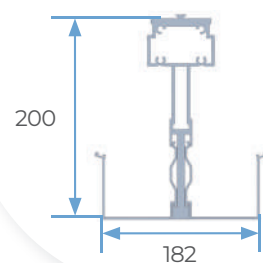

⑨ **UNION BEAM (L)**

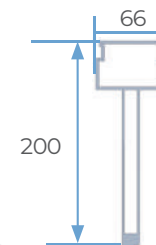

VARIETY OF CONFIGURATIONS

A -SUPPORT TYPES

- Adjustable
- Adjustable reinforced



Adjustable Reinforced Support

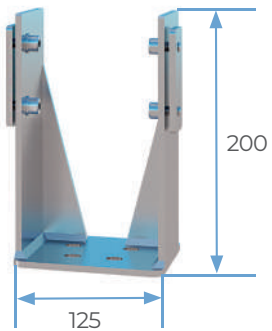

Adjustable Support

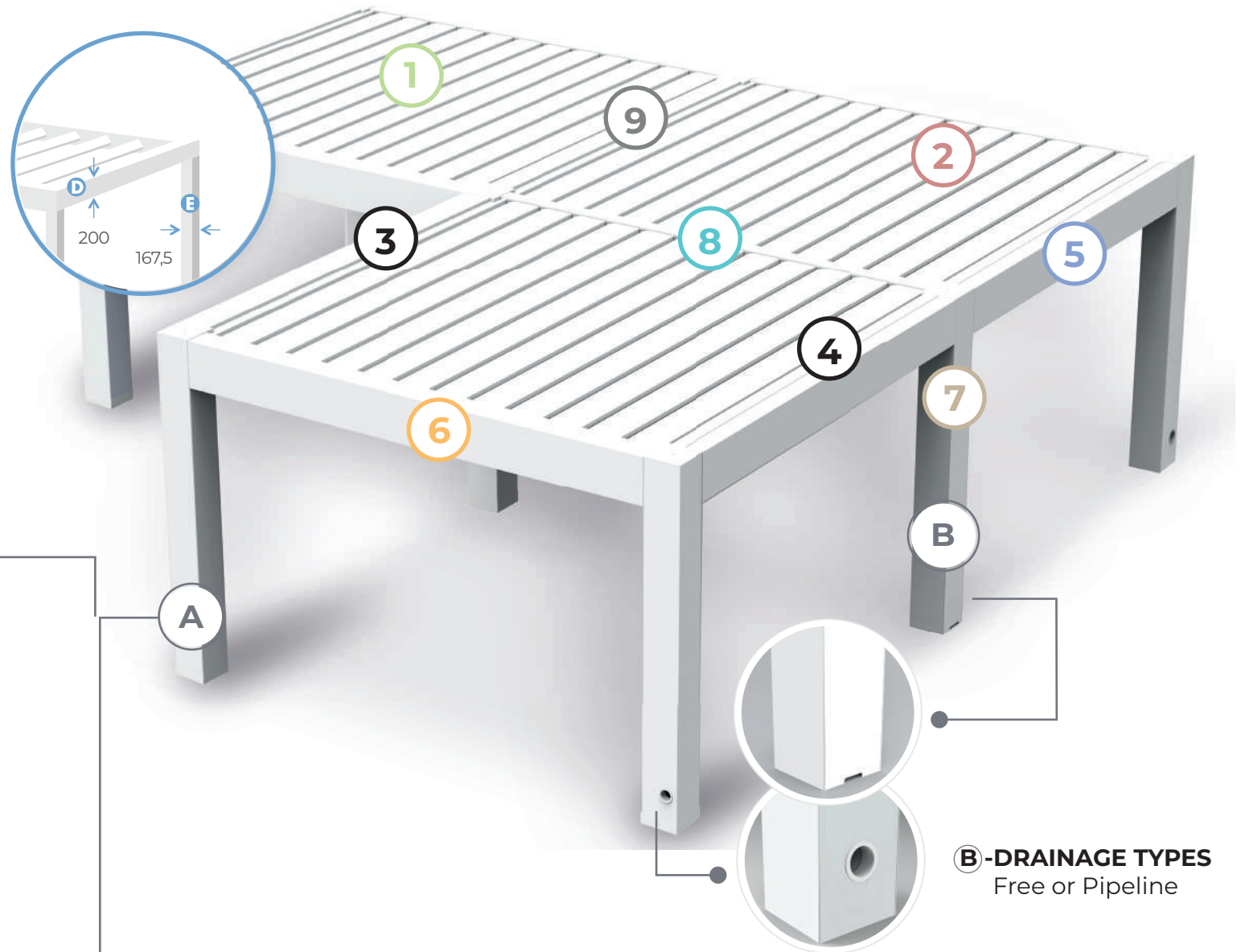

B-DRAINAGE TYPES
Free or Pipeline

Possible configurations

MAXIMUM DIMENSIONS

Seesky-bio can be custom made using different variations, depending on where the installation will take place so it can be adapted to customer's needs.

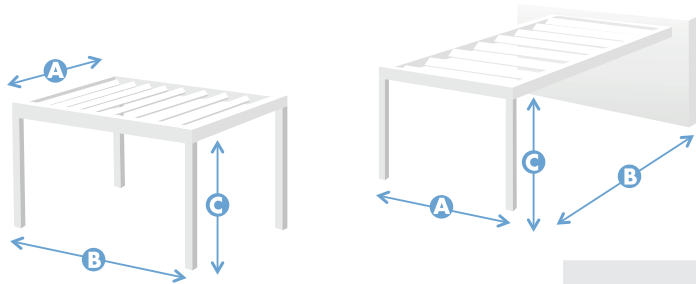

4 6 2 COLUMNS

A	Maximum width	4.700 mm
B	Maximum lenght	6.450 mm
C	Maximum height	3.000 mm

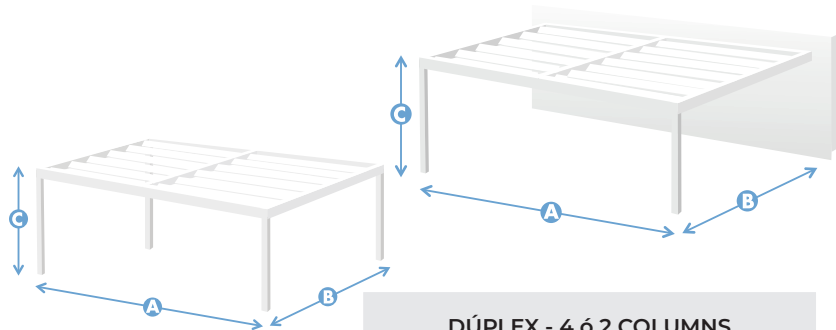

DÚPLEX - 4 6 2 COLUMNS

A	Maximum width	6.500 mm
B	Maximum lenght	6.450 mm
C	Maximum height	3.000 mm

VARIETY OF CONFIGURATIONS

Seesky-bio can be custom made using different variations, depending on where the installation will take place so it can be adapted to customer's needs. There are 4 different configurations.

A ISLAND

The most common configuration, installed with 4 columns.

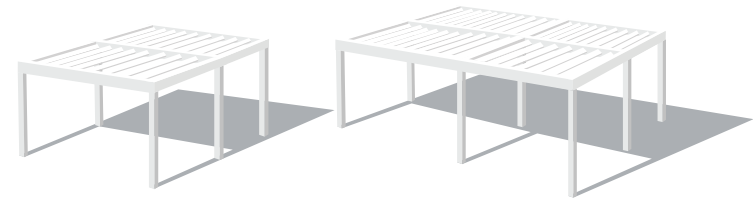

B PORTICO

Mixed configuration of 2 types of supports: columns and wall supports.

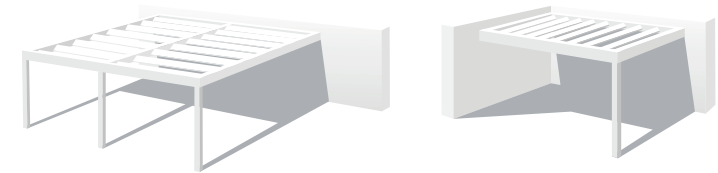

C INBETWEEN CONFIGURATION (WITHOUT COLUMNS)

For this configuration only wall supports are used.

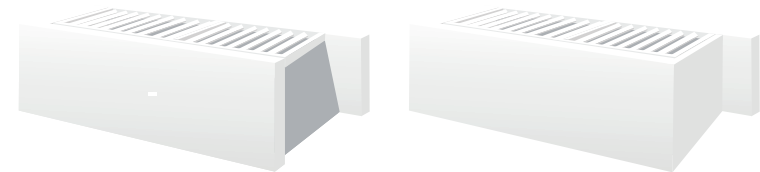

D DÚPLEX

Pergola connection without intermediate columns.

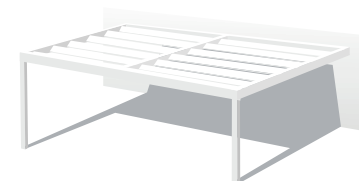

CABLE ATTACHMENT

There is a possibility of fastening pergola to the wall and allowing an installation without columns.

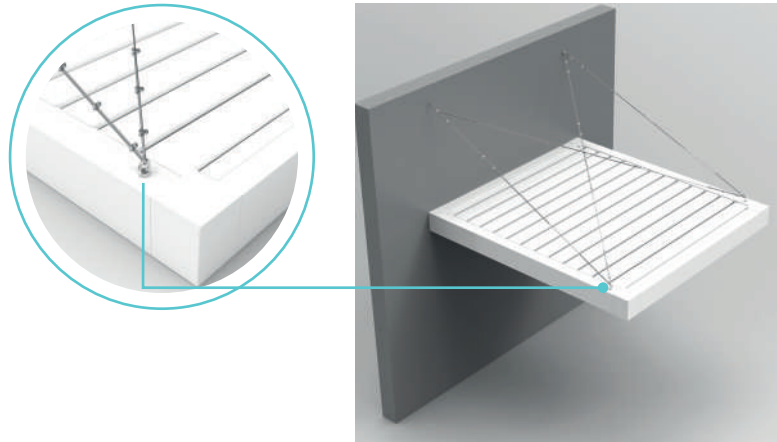

SHIFTEN COLUMN

Pergola can be adapted to existing structures thanks to shifted column option (maximum 1000 mm).

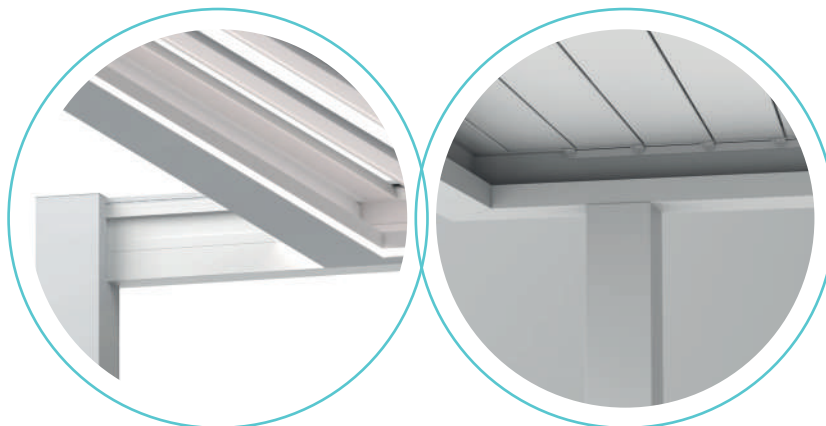



AUTOMATION

The Seesky BIO bioclimatic pergola offers the possibility of unifying home automation controls so that you can create the ideal environment in your home wherever you are. Thanks to the home automation integrated into the available options of the pergola, it is possible to optimize the use of energy to the maximum. Live a unique experience where comfort and well-being become the protagonists. The quality of C3 Systems in a highly sustainable and efficient system.

You can independently control each room. Going to an ecofriendly way to improve consumption in terms of ventilation, air conditioning and heating...

Create bespoke outdoor scenarios: programming the lighting, regulating the temperature of the room by opening or closing the slats, activate the temperature sensor... All this and much more in a single click.

Smart spaces for smart people. An innovative system designed for you.

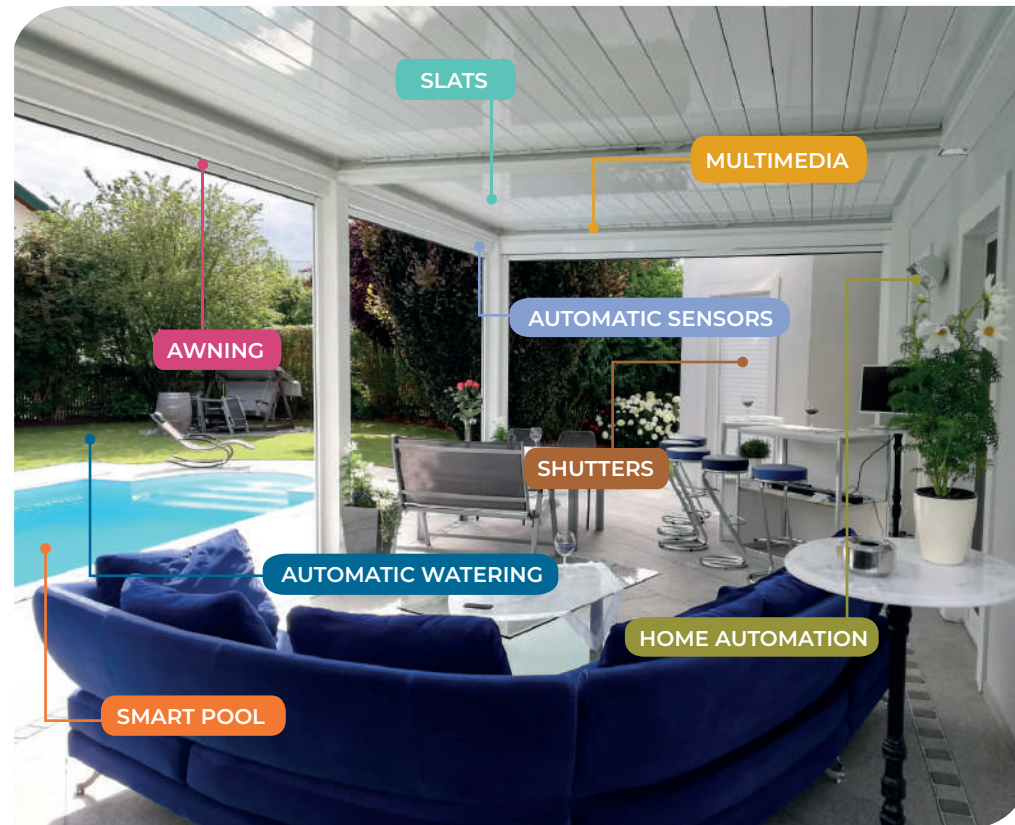



LIGHTING

The lighting LED is integrated into the pergola in two types of formats:

- LED light in *STD* slat.
- Perimeter LED light.

Also, there are three kinds of color options:

- Warm white (3000K), neutral white (4000K)
- RGB



LED light in slat



Perimeter LED light



CLIMATIC SENSOR

Thanks to this unique sensor, the pergola adapts to weather conditions that may occur unexpectedly.

This automation of the seesky-bio bioclimatic pergola allows you to deal with any inclement weather without worrying about activating the different devices.

In addition, it can be configured according to the most common weather conditions in the environment.



SLIDING AND FOLDING GLAZING SYSTEMS

With sliding and folding system [seeglass-one-sub](#) you will protect the inside pergola without giving up the view and to open everything completely.

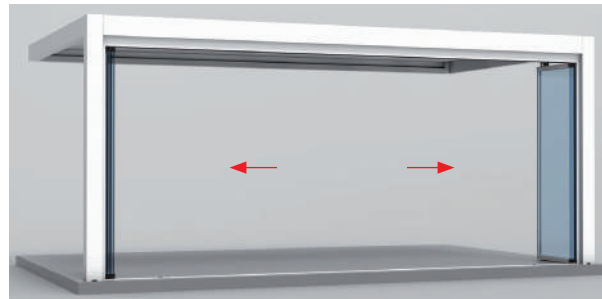

SLIDING SYSTEMS

With sliding systems [seeglass-run](#) you will protect the inside of the pergola without invading interior space.

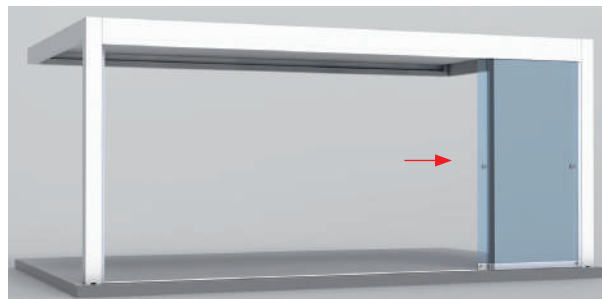
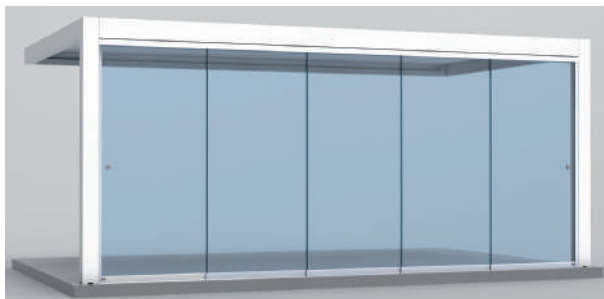

ADJUSTABLE WIND SCREENS

habitat win®

Combined with adjustable windscreen **habitat-win**, protect the inside from windy weather.

Also available in a fixed version with a door, with an opening of up to 180°. It provides permanent wind protection without compromising comfort.

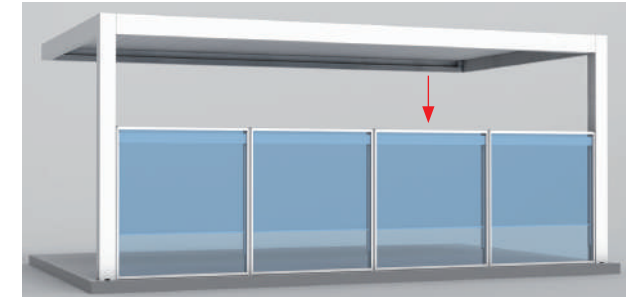
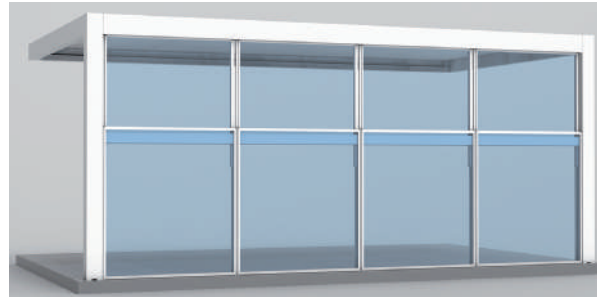

SUN PROTECTING ZIP SCREEN

habitat zip®

Sun protecting zip screens allow to protect the inside of the pergola from excessive heat and wind.

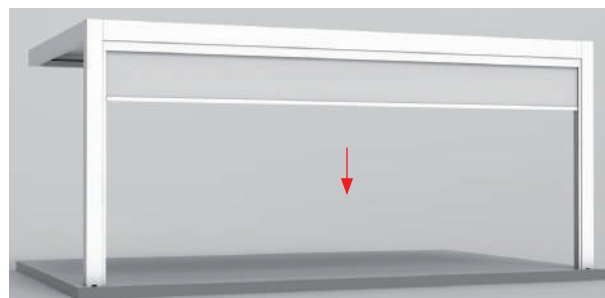

MOSQUITO NET

habitat net®

Combine mosquito screen habitat-net with your pergola and you are going to be able to yourself from different kinds of insects. With a minimalistic design and simple functioning, it will be a perfect complement for your pergola.

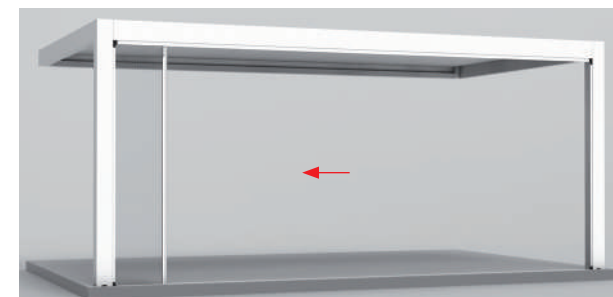

Seesky-bio is available in all the finishes of the RAL color range, textured and matt. Visit our website to see our wide range of finishes.



The aluminum profiles used to manufacture these items comply with:

ALLOYS AND EXTRUSION

Pergolas profiles are extruded in compliance with the UNE EN 12020-1 Standard

correspond to extruded aluminum alloy 6063 and T5 heat treatment. They comply with the composition characteristics, according to the requirements established in the UNE-EN 573-3 Standard.

comply with the dimensional tolerances, as specified in the UNE-EN 755-2 Standard.

LACQUERED SURFACE TREATMENT

The lacquered profiles are treated in facilities authorized for the use of the QUALICOAT Quality Mark for PAINTING, LACQUERING and POWDER COATING OF ALUMINUM FOR ARCHITECTURE, in compliance with the specifications of the QUALICOAT Quality Mark Guidelines.



Why should we use aluminum for the systems of the future?

FOR ITS ENVIRONMENTAL ADVANTAGE

It is the only material that is 100% recyclable and reusable infinitely many times.

It is the only 100% sustainable and is effectively recycled. The high price of its scrap proves it.

The mineral with which it is produced is practically inexhaustible.

It is the only one that promotes 100% circular economy.





Testing and Certificates

TESTING AND CERTIFICATES

Seesky-BIO has test certificates in an approved laboratory, established by national and international legal regulations, issued by the corresponding certification bodies.

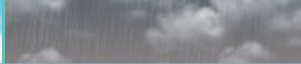
This certification ensures that by choosing C3 Systems, S.L. You are acquiring a quality product with all the necessary guarantees.

HIGHEST QUALIFICATION IN THE TEST*		
 <p>Wind-strength UNE EN 1932:2014 CLASS 6 - 100 km/h</p>	 <p>Watertightness UNE EN 14963:2007 210 l/m² (hour)</p>	 <p>Snow load UNE EN 12833 245 kg/m² New milestone!</p>
 *Tests performed after maximum measurements (6450x4700x3000mm.)		



Guarantee of manufacturing quality and safety of products from manufacturers in the metal sector, including those of metal structures.



CE Marking

All our systems are approved by an official laboratory and in accordance with the requirements of the European Commission to bear the CE Marking seal. We have all the tests and certificates that comply with this regulation and we have a computer tool that makes it easier for the workshop to obtain this label.



5 year warranty*

Seesky BIO has a 5-year warranty on all components and a 3-year warranty on electrical components.

*(See document in the client area - B2B).





MADE IN SPAIN



C3 Systems, S.L. · C/ Ibi, 13 · Polígono Industrial Cachapets
03330 Crevillente (Alicante) España
Telf. +34 966 286 186
c3systems@c3systems.es · www.c3systems.es



ED. 11 - 2025

The purpose of this document is for commercial purpose. It does not constitute an authentic advertising offer in "strict sense". For the official offer, please contact C3 Systems S.L. in order to receive specific and personalized information that contains objective information regarding relevant characteristics which means that it will constitute an offer in a "strict sense".

C3 Systems S.L. commits not to make misleading advertising by this means. To these effects, therefore, formal or numerical errors that could be found in the content of this document are not considered as misleading advertising, in particular regarding to the image accompanying in an illustrative way, and not contractual. In any case C3 Systems S.L. commits to correct it as soon as it becomes aware of such errors.