

seeglass lux[®]

For design lovers





SLIDING GLASS PANELS



Seeglass-lux is a sliding glass panel system designed to separate interior spaces. This solution, specially created to optimise the passage of natural light and energy efficiency. It is ideal both for homes and for offices, restaurants, hotels, etc..

Thanks to the lateral sliding movement of the glass panels, special configurations are generated that allow the movable partitions to be hidden inside walls or in specific architectural sections (recesses, walkways, etc.)











The new **industrial style decoration** option, , which we have introduced as a distinctive new product at **Seeglass-lux**, has a digital thermal printing incorporated in the glass itself, which gives it a modern and differentiating effect.

Its minimalist, matt black design combines perfectly with the various system drives and accessories, and creates a chromatic harmony in the room that everyone who sees it will fall in love with.





SYSTEM ADVANTAGES

-  Suitable for indoor use.
-  Top-quality product.
-  Easy installation, handling and cleaning.
-  Range of applications (HORECA, establishments and housing).
-  Optimisation of natural daylight.
-  Utilising available spaces.
-  Stylish and trendy design.
-  Adaptable to any space, protecting its structures and elements.
-  Minimal component wear.
-  Energy efficiency and sustainability.

MULTIPLE CONFIGURATIONS

Due to the large number of possible configurations, central connections can be created to link several systems.

Especially recommended to cover large widths or to achieve commercial style doors.

It is a simple frame connection, which allows several sections to be joined together to make the most of large spaces.

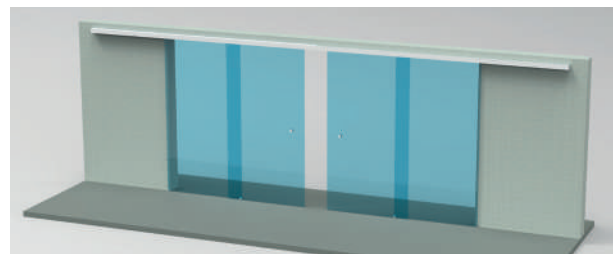



POSSIBLE CONFIGURATIONS

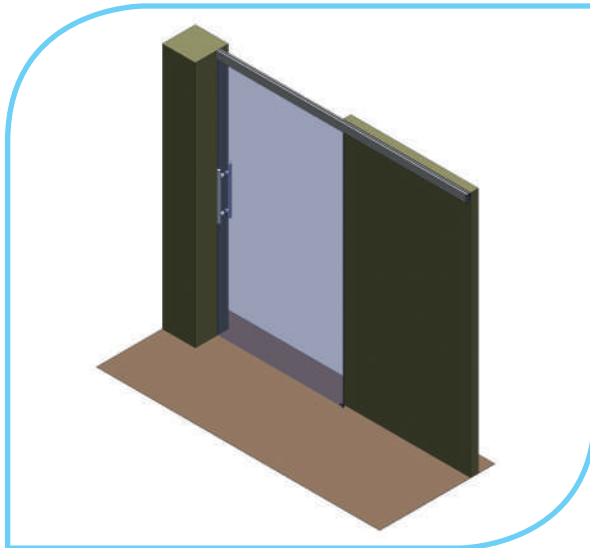

MODEL M1

System consisting of 1 sliding panel, perfect for separating small spaces and different ambiances.

| | |
|------------------|---------|
| Max. High | 3000 mm |
| Max. Width | 1500 mm |
| Max. panel width | 1500 mm |

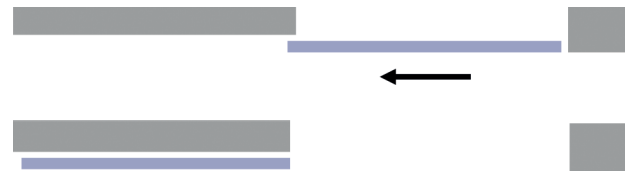

To ceiling

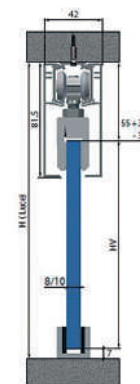

To wall

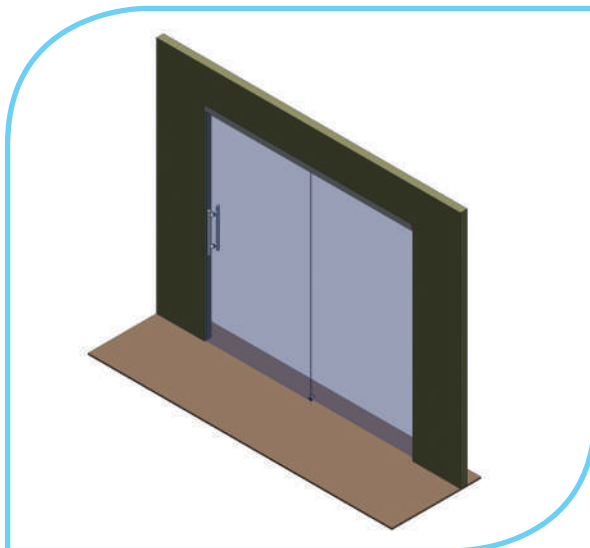
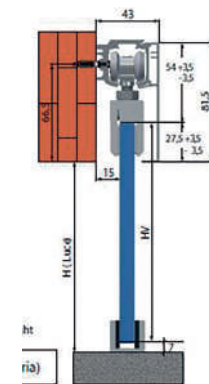

MODEL M1F

System consisting of 1 sliding panel and 1 movable panel.

| | |
|------------------|---------|
| Max. High | 3000 mm |
| Max. Width | 3000 mm |
| Max. panel width | 1500 mm |

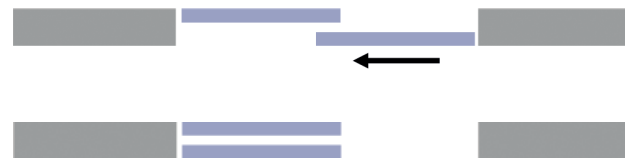

To ceiling

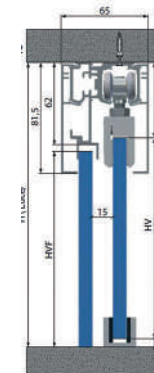

To wall

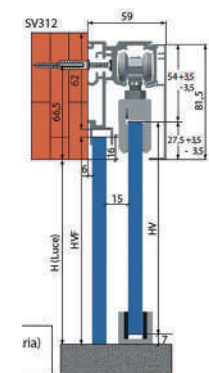

POSSIBLE CONFIGURATIONS

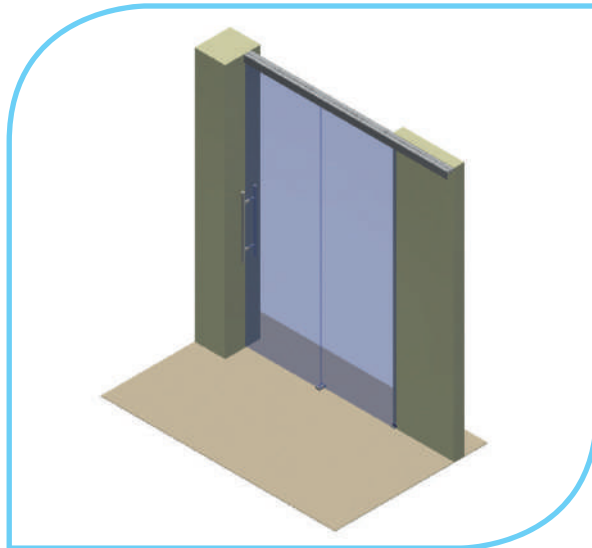

MODEL M2

System consisting of 2 sliding panels.

| | |
|------------------|---------|
| Max. High | 3000 mm |
| Max. Width | 3000 mm |
| Max. panel width | 1500 mm |

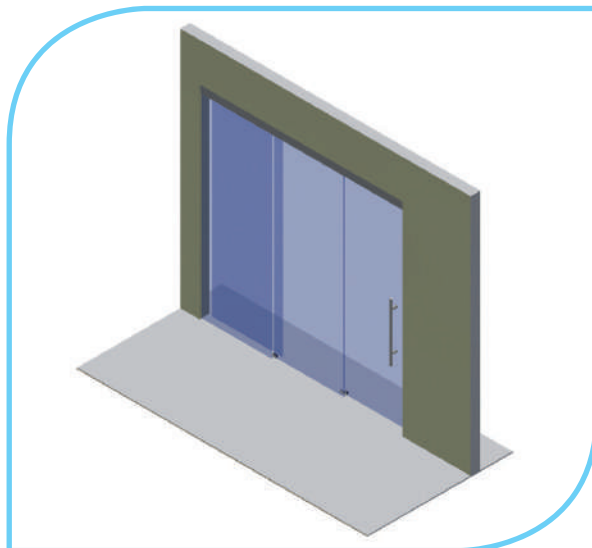
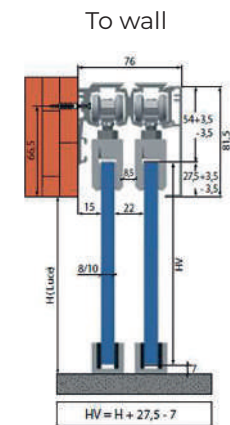
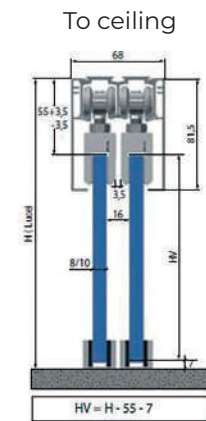

MODEL M2F

System consisting of 2 sliding paneles and 1 movable panel.

| | |
|------------------|---------|
| Max. High | 3000 mm |
| Max. Width | 4500 mm |
| Max. panel width | 1500 mm |

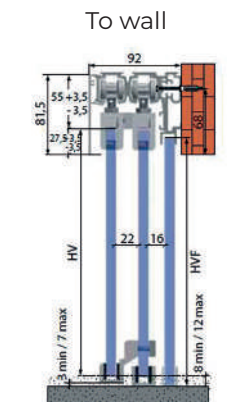
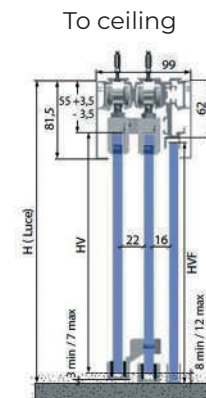
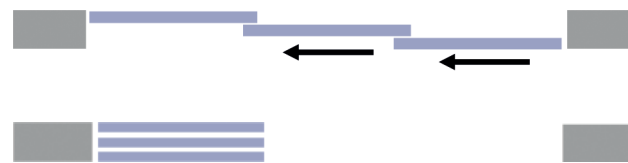

POSSIBLE CONFIGURATIONS

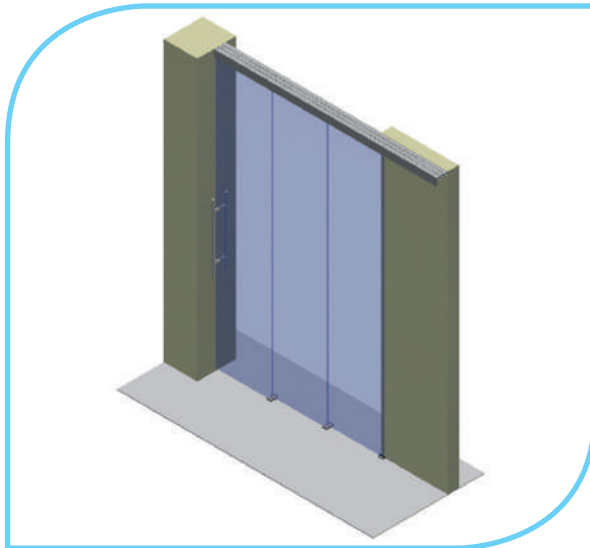

MODEL M3

System consisting of 3 sliding panels.

| | |
|------------------|---------|
| Max. High | 3000 mm |
| Max. Width | 3200 mm |
| Max. panel width | 1400 mm |

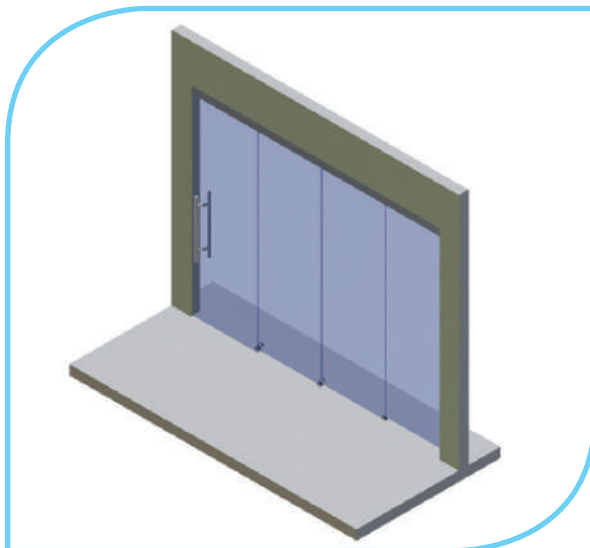
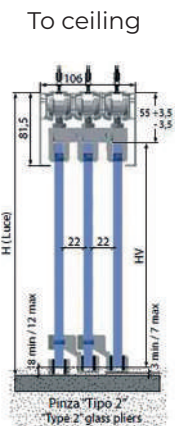
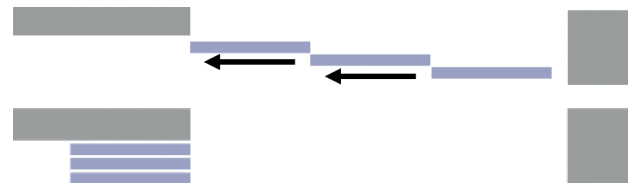

MODEL M3F

System consisting of 3 sliding panels and 1 movable panel.

| | |
|------------------|---------|
| Max. High | 3000 mm |
| Max. Width | 5600 mm |
| Max. panel width | 1400 mm |

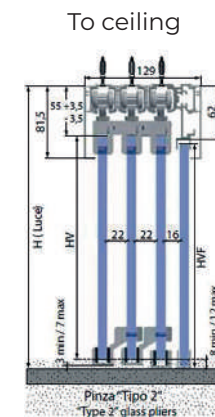
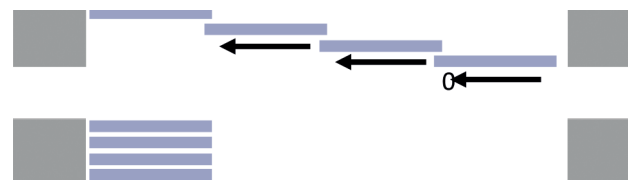

POSSIBLE CONFIGURATIONS

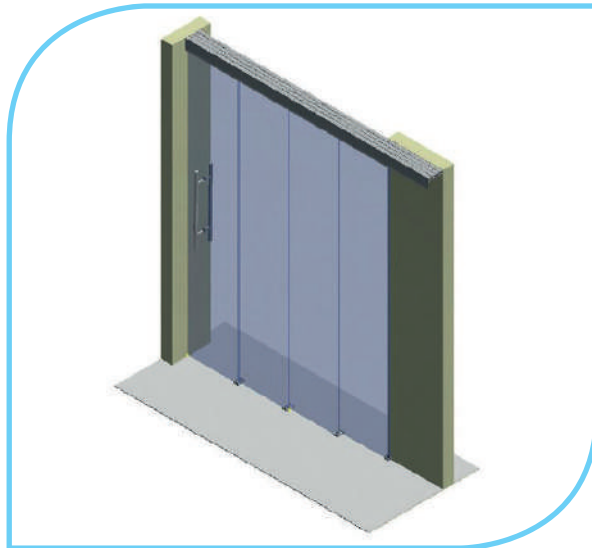

MODEL M4

System consisting of 4 sliding panels.

| | |
|------------------|---------|
| Max. High | 3000 mm |
| Max. Width | 4400 mm |
| Max. panel width | 1100 mm |

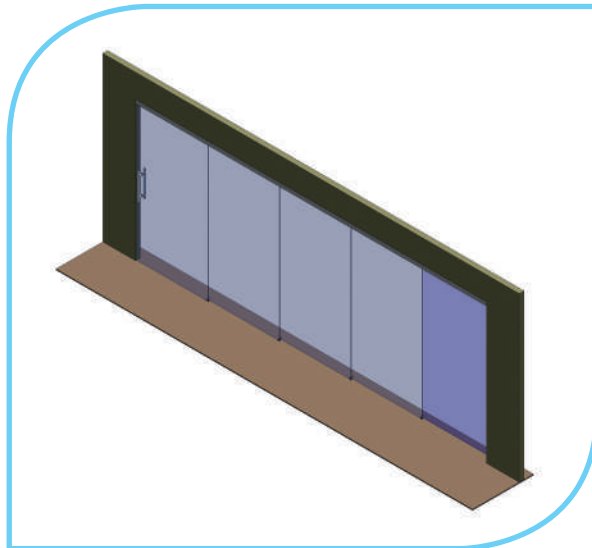
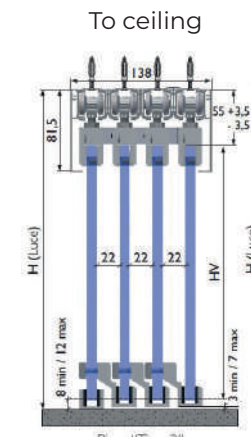
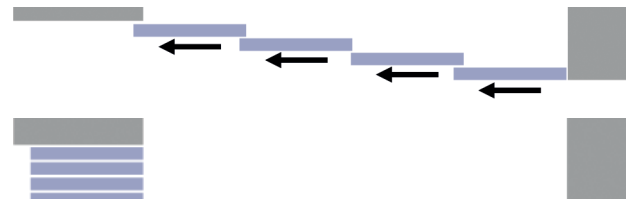

MODEL M4F

System consisting of 4 sliding panels and 1 movable panel.

| | |
|------------------|---------|
| Max. High | 3000 mm |
| Max. Width | 5500 mm |
| Max. panel width | 1100 mm |

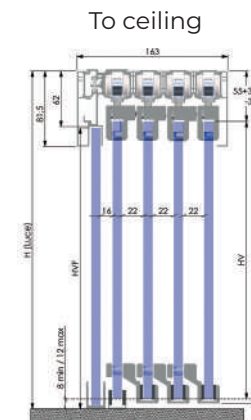
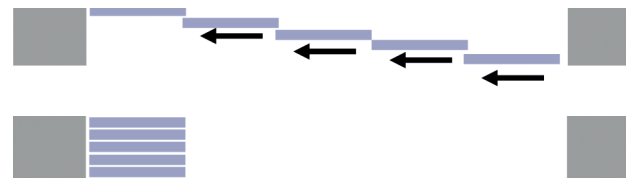



RING HANDLE - STANDARD OPENING DEVICE

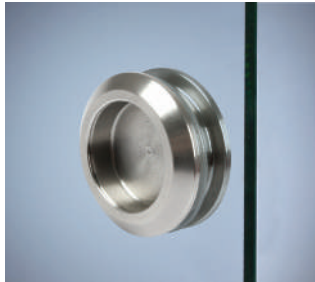

60 mm diameter Round opening device.

Finish: Glossy Chrome and Matt Black

S-6 LOCK



Locking device with either 2 keyholes on both sides, or outside key outside and inside knob.

Finishes: Polished or matt chrome, matt black or imitation INOX.

MOBILE PANEL HANDLE



It allows to ergonomically move the panel without touching the glass. Includes a handle inside.

Finishes: matt aluminium, gloss chrome and satin aluminium.



ACCESORIES AND SUPPORTS

SOFT STOP KIT

Hydraulic damping system that allows panels closing and opening in a controlled manner to prevent these and the systems from being damaged.

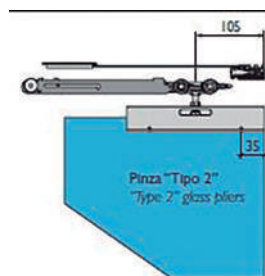

| MAX/MIN GLASS MEASURES | | | | |
|------------------------|------------------|------------------|-------|--------|
| Type | Simple Soft Stop | Double Soft Stop | Mín. | Máx. |
| STD | Not available | Not available | 500mm | 1500mm |
| STD | 1 Ud. | Not available | 560mm | 1500mm |
| STD | Not available | 1 Ud. | 790mm | 1100mm |

LOWER GUIDES

Lower aluminum guides System placed on glass panels lower edges, which guarantees lateral movement.

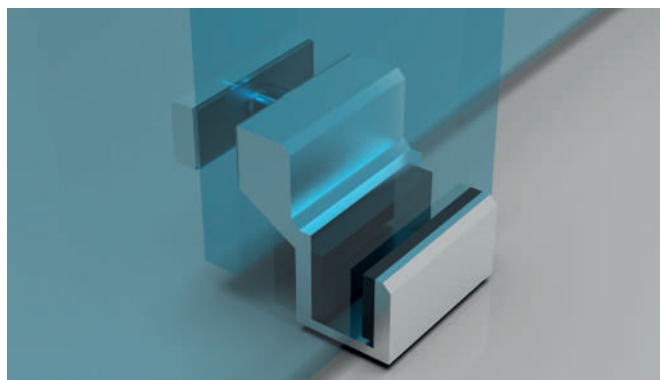

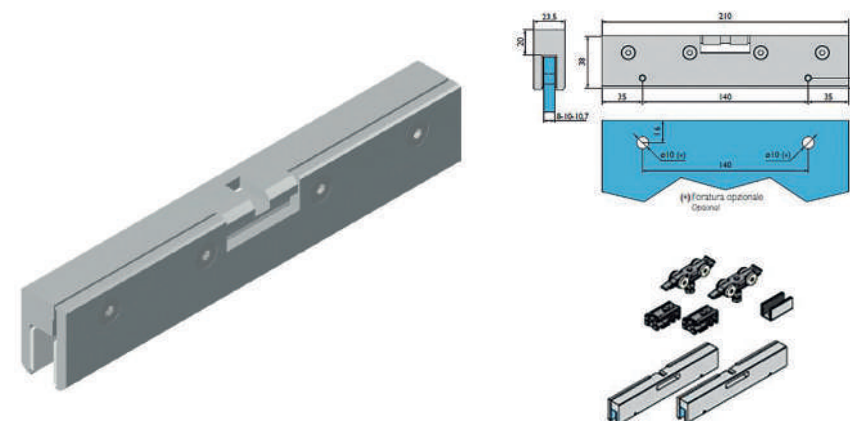

HOLDING PLIERS

High strength pliers and jaws specially designed to support glass panels of large size and weight.





| COLOURS IN STOCK - ANODISED | |
|-----------------------------|--|
| SILVER ANODISED GR/PUL |  |
| ANODISED INOX |  |

| TEXTURED AND MATT | |
|-------------------|---|
| 9011 MATT |  |



Please consult availability, price and delivery time for other RAL, anodised and Imitation Wood finishes.

CERTIFICATIONS



3 years warranty*.

*(Please download the general terms and conditions of sale in the customer area of the website to check the warranty in detail).



Seeglass-lux conforms to international standards for **Qualanod, Qualideco y Qualicoat**



Seeglass is **CE marked**.

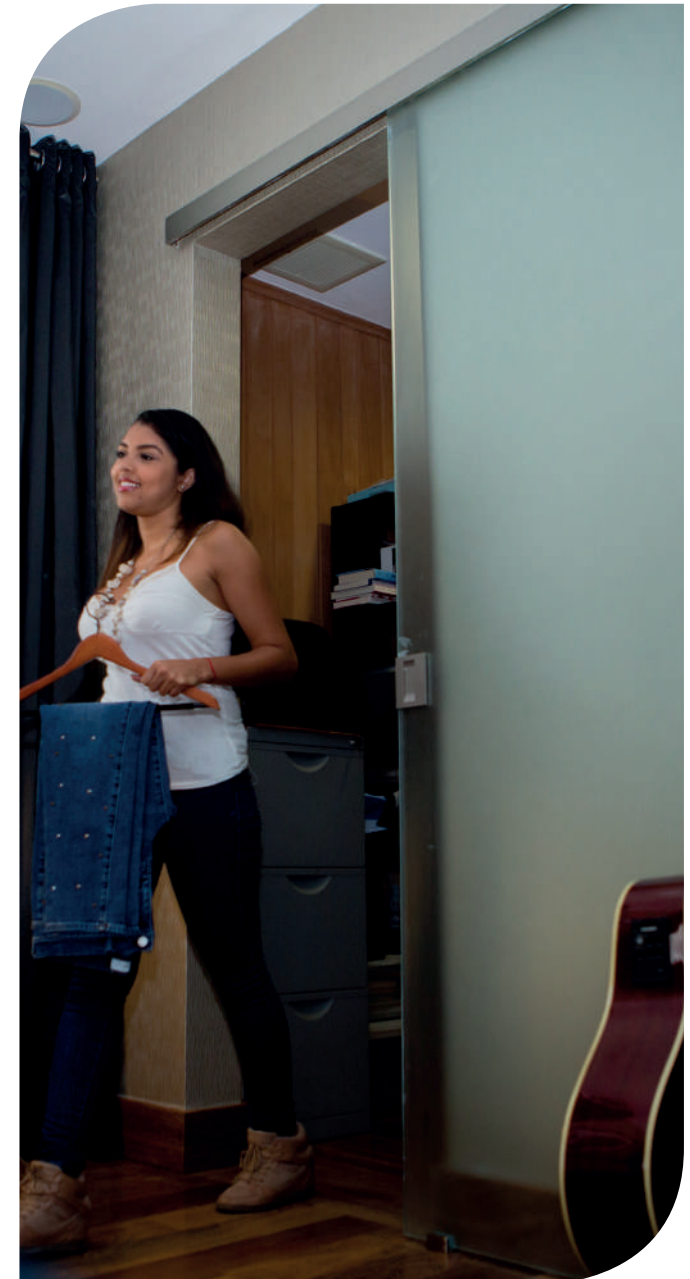



C3 Systems, S.L. · C/ Ibi, 13 · Polígono Industrial Cachapets
03330 Crevillente (Alicante) España
Telf. +34 966 286 186
c3systems@c3systems.es · www.c3systems.es

MADE IN SPAIN



ED. 6 - 2023

The purpose of this document is for commercial purpose. It does not constitute an authentic advertising offer in "strict sense". For the official offer, please contact C3 Systems S.L. in order to receive specific and personalized information that contains objective information regarding relevant characteristics which means that it will constitute an offer in a "strict sense".

C3 Systems S.L. commits not to make misleading advertising by this means. To these effects, therefore, formal or numerical errors that could be found in the content of this document are not considered as misleading advertising, in particular regarding to the image accompanying in an illustrative way, and not contractual. In any case C3 Systems S.L. commits to correct it as soon as it becomes aware of such errors.